

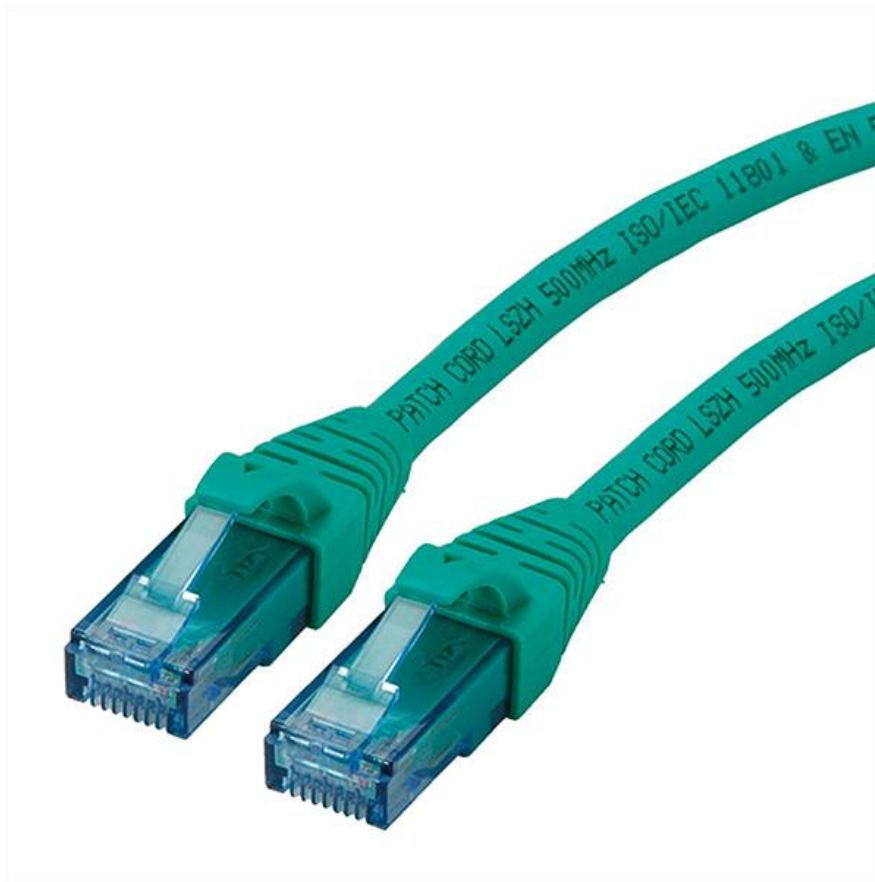

Datenblatt - Fiche technique - Data sheet

21.15.2733



ROLINE Patchkabel Kat.6A UTP, Component Level, LSOH, grün, 3,0 m

Cordon ROLINE UTP Cat.6A / 10 Gigabit, Component Level, LSOH, vert, 3,0 m

ROLINE UTP Patch Cord Cat.6A, Component Level, LSOH, green, 3.0 m

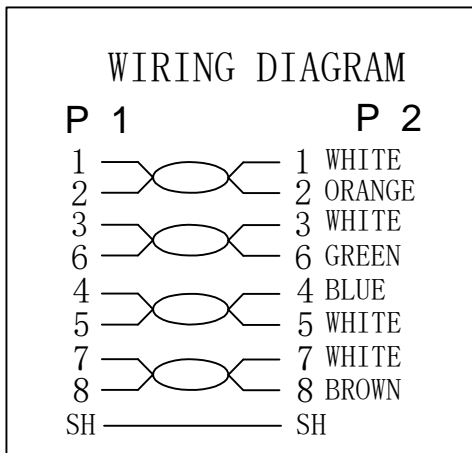
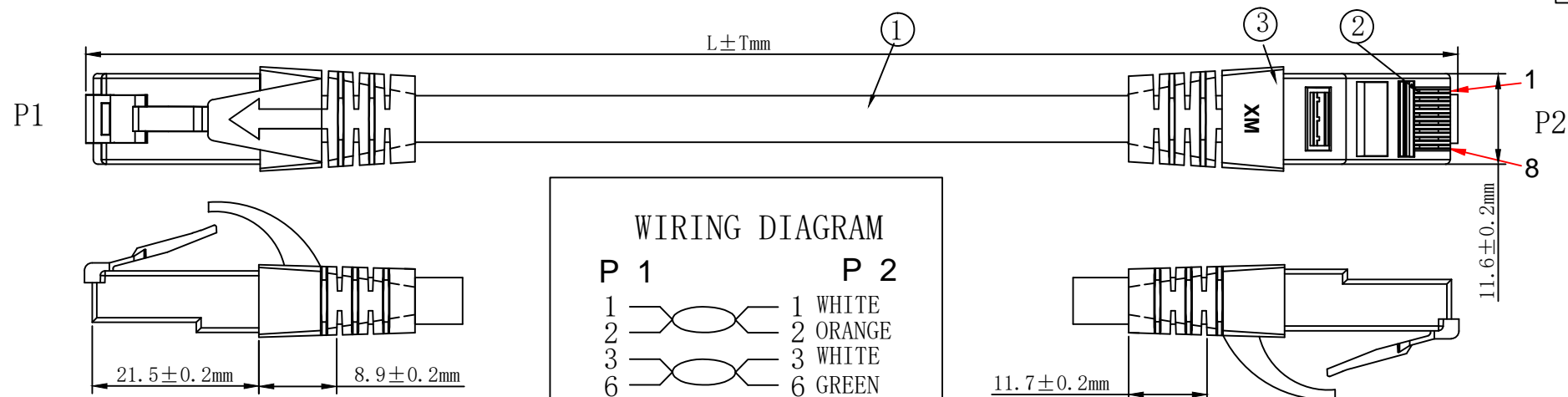

1. ELECTRICAL TEST:

- (1).100% OPEN SHORT & MISS WIRE TEST;
- (2).INSULATION RESISTANCE:DC 250V 20M OHM MIN;
- (3).CONTACTOR RESISTANCE:30 OHM MAX

2.PRINTING:GHMT® roline CAT.6A U/UTP COMPONENT PATCH CORD LSZH 500MHZ ISO/IEC

11801 & EN 50173-1 & ANSI/TIA-568-C.2

3.100% Component Patch cord Test PASS

4.Minimum bending radius:60mm

MATERIAL LIST

⑥	LABEL	NO DRY GLUE LABEL	1PCS	
⑤	MINI TIE	PE MINI TIE(POSSESS METAL)	2PCS	
④	POLYETHYLENE BAG	POLYETHYLENE BAG	1PCS	
③	OVER MOLD	88A PVC Green	2PCS	
②	CONNECTOR	RJ45 8P8C'S UNSHIELDED PIN GOLD PLATED 3u", Transparent Blue	2PCS	
①	CABLE	S/FTP CAT.6A 26AWG (BC*1P+AL-FOIL)*4P+BRAID CABLE JACKET LSOH OD=6.2±0.2MM	1PCS	
NO.	PARTS NAME	SPECIFICATION STANDARD	QT' Y	REMARK

COLOUR:Green (PANTONE:3278C)		
ITEM NO.	LENGTH (L)	TOLERANCE (T)
21. 15. 2984	300mm	± 10mm
21. 15. 2730	500mm	± 15mm
21. 15. 2731	1000mm	± 30mm
21. 15. 2734	1500mm	± 45mm
21. 15. 2732	2000mm	± 60mm
21. 15. 2733	3000mm	± 90mm
21. 15. 2735	5000mm	± 150mm
21. 15. 2736	7500mm	± 210mm
21. 15. 2737	10000mm	± 300mm
21. 15. 2738	15000mm	± 450mm
21. 15. 2739	20000mm	± 600mm

ITEM NO.	21. 15. 2984	21. 15. 2730	21. 15. 2731	21. 15. 2732	21. 15. 2733
21. 15. 2734	21. 15. 2735	21. 15. 2736	21. 15. 2737	21. 15. 2738	21. 15. 2739
DESC.	ROLINE U/UTP PatchCord CAT. 6A, LSOH, Comp. Level, Green				



		NEW		2016-09-13	A
BY	CHK	REVISION RECORD MODIFICATIONS		DATE	REV.