



PHANTOM S

USB Gamepad Emulator

User Manual



FCC Information

Federal Communication Commission Interference Statement: This equipment has been tested and found to comply with the limits for a Class B digital service, pursuant to Part 15 of the FCC rules. These limits are designed to provide reasonable protection against harmful interference in a residential installation. Any changes or modifications made to this equipment may void the user's authority to operate this equipment. This equipment generates, uses, and can radiate radio frequency energy. If not installed and used in accordance with the instructions, may cause harmful interference to radio communications. However, there is no guarantee that interference will not occur in a particular installation.

This device complies with Part 15 of the FCC Rules. Operation is subject to the following two conditions: (1) this device may not cause harmful interference, and (2) this device must accept any interference received, including interference that may cause undesired operation.

If this equipment does cause harmful interference to radio or television reception, which can be determined by turning the equipment off and on, the user is encouraged to try to correct the interference by one or more of the following measures:

- ◆ Reorient or relocate the receiving antenna.
- ◆ Increase the separation between the equipment and receiver.
- ◆ Connect the equipment into an outlet on a circuit different from that to which the receiver is connected.
- ◆ Consult the dealer or an experienced radio/TV technician for help.

FCC Caution: Any changes or modifications not expressly approved by the party responsible for compliance could void the user's authority to operate this equipment.

RoHS

This product is RoHS compliant.



SJ/T 11364-2006

The following contains information that relates to China.

| 部件名称 | 有毒有害物质或元素 | | | | | |
|------|-----------|---|---|-----|------|-------|
| | 铅 | 汞 | 镉 | 六价铬 | 多溴联苯 | 多溴二苯醚 |
| 电器部件 | ● | ○ | ○ | ○ | ○ | ○ |
| 机构部件 | ○ | ○ | ○ | ○ | ○ | ○ |

- : 表示该有毒有害物质在该部件所有均质材料中的含量均在SJ/T 11363-2006规定的限量要求之下。
- : 表示符合欧盟的豁免条款，但该有毒有害物质至少在该部件的某一均质材料中的含量超出SJ/T 11363-2006的限量要求。
- ×: 表示该有毒有害物质至少在该部件的某一均质材料中的含量超出SJ/T 11363-2006的限量要求。

User Information

Online Registration

Be sure to register your product at our online support center:

| | |
|---------------|---|
| International | http://eservice.aten.com |
|---------------|---|

Telephone Support

For telephone support, call this number:

| | |
|----------------|-------------------------|
| International | 886-2-8692-6959 |
| China | 86-400-810-0-810 |
| Japan | 81-3-5615-5811 |
| Korea | 82-2-467-6789 |
| North America | 1-888-999-ATEN ext 4988 |
| United Kingdom | 44-8-4481-58923 |

User Notice

All information, documentation, and specifications contained in this manual are subject to change without prior notification by the manufacturer. The manufacturer makes no representations or warranties, either expressed or implied, with respect to the contents hereof and specifically disclaims any warranties as to merchantability or fitness for any particular purpose. Any of the manufacturer's software described in this manual is sold or licensed *as is*. Should the programs prove defective following their purchase, the buyer (and not the manufacturer, its distributor, or its dealer), assumes the entire cost of all necessary servicing, repair and any incidental or consequential damages resulting from any defect in the software.

The manufacturer of this system is not responsible for any radio and/or TV interference caused by unauthorized modifications to this device. It is the responsibility of the user to correct such interference.

The manufacturer is not responsible for any damage incurred in the operation of this system if the correct operational voltage setting was not selected prior to operation. **PLEASE VERIFY THAT THE VOLTAGE SETTING IS CORRECT BEFORE USE.**

Package Contents

Package

The Phantom-S package consists of:

- ◆ 1 Phantom-S USB Gamepad Emulator
- ◆ 1 1.8 m mini USB to USB cable
- ◆ 1 1 m mini USB to USB cable
- ◆ 1 1 m 3.5mm to 3.5mm cable
- ◆ 1 User Instructions*

Check to make sure that all the components are present and that nothing got damaged in shipping. If you encounter a problem, contact your dealer.

Read this manual thoroughly and follow the installation and operation procedures carefully to prevent any damage to the unit, and/or any of the devices connected to it.

* Features may have been added to the Phantom-S since this manual was published. Please visit our website to download the most up-to-date version.

© Copyright 2017 ATEN® International Co., Ltd.

F/W Version: V1.2.117
Manual Date: 2017-07-31

ATEN and the ATEN logo are registered trademarks of ATEN International Co., Ltd. All rights reserved.
All other brand names and trademarks are the registered property of their respective owners.

Contents

| | |
|-------------------------------|-----|
| FCC Information | ii |
| RoHS | ii |
| SJ/T 11364-2006 | iii |
| User Information | iv |
| Online Registration | iv |
| Telephone Support | iv |
| User Notice | iv |
| Package Contents | v |
| Package | v |
| About this Manual | ix |
| Conventions | x |
| Product Information | x |

Chapter 1.

Introduction

| | |
|-------------------------------------|---|
| Overview | 1 |
| Features | 2 |
| Requirements | 3 |
| Game Console / Controller | 3 |
| Keyboard and Mouse | 3 |
| Audio Support | 3 |
| Operating Systems | 3 |
| Components | 4 |
| Front View | 4 |
| Rear View | 5 |

Chapter 2.

Setup

| | |
|---|----|
| Getting Started | 6 |
| Connecting Hardware | 6 |
| Game Console | 6 |
| Computer | 7 |
| Computer / Laptop + Console Setup | 9 |
| PS4 Remote Play / Xbox Game Streaming | 10 |
| Quick Start Mouse Configuration | 12 |
| Mouse Settings | 13 |
| DPI | 13 |
| Report Rate | 13 |

Chapter 3.

Basic Operation

| | |
|---------------------------|----|
| Overview | 14 |
| Basic Operation | 14 |
| Mouse Map | 14 |
| Keyboard Map | 15 |

| | |
|-------------------------------------|----|
| Function Keys & Caps Lock | 16 |
| Direct Configuration | 18 |
| Beeps | 18 |
| Direct Mapping Mode | 19 |
| Deadzone Delay | 21 |
| Testing the Deadzone | 23 |
| Decrease Deadzone | 23 |
| Increase Deadzone | 23 |
| Keyboard / Gamepad Mode | 24 |
| Turbo Mode | 24 |
| Play Mode | 25 |

Chapter 4.

Phantom-S Software

| | |
|--------------------------------|----|
| Overview | 26 |
| Downloading | 26 |
| Phantom-S Interface | 28 |
| Software Overview | 31 |
| Groups | 32 |
| Profiles | 33 |
| Upload | 35 |
| Customizing Controls | 37 |
| Button Mapping | 38 |
| Turn Assist | 41 |
| Sensitivity | 42 |
| A. Mouse Movement | 43 |
| B. Curve Setting | 44 |
| Settings | 44 |
| Curve | 45 |
| Adjusting the Curve | 47 |
| C. Deadzone Settings | 50 |
| Setting the Deadzone | 51 |
| Macro Settings | 54 |

Chapter 5.

Profile-X Web Portal

| | |
|----------------------------|----|
| Overview | 59 |
| Login | 59 |
| The Main Page | 60 |
| Components | 60 |
| New | 62 |
| Components | 62 |
| Board | 63 |
| Components | 63 |
| Posting Messages | 64 |
| Request Profile | 64 |
| Share Profile | 64 |

| | |
|-----------------------|----|
| Share Video | 65 |
| ATEN | 66 |
| Components | 66 |
| Follow | 67 |
| Components | 67 |
| My Account | 68 |
| Components | 68 |

Chapter 6.

Firmware Upgrade

| | |
|--|----|
| The Firmware Upgrade Utility | 70 |
| Before You Begin | 70 |
| Performing the Upgrade | 71 |
| Starting the Upgrade | 71 |
| Upgrade Succeeded | 72 |
| Upgrade Failed | 73 |

Appendix

| | |
|--|----|
| Safety Instructions | 75 |
| General | 75 |
| Technical Support | 77 |
| International | 77 |
| North America | 77 |
| Specifications | 78 |
| Limited Hardware Warranty | 79 |
| What is covered by the Limited Hardware Warranty | 79 |

About this Manual

This User Manual is provided to help you get the most from your system. It covers all aspects of installation, configuration and operation. An overview of the information found in the manual is provided below.

Chapter 1, *Introduction*, introduces you to the Phantom-S. Its purpose, features, benefits, and requirements are presented, and its front and back panel components are described.

Chapter 2, *Setup*, describes how to set up your Phantom-S. The necessary steps for configuring the mouse settings and hardware setup are provided.,

Chapter 3, *Basic Operation*, describes how to use the keyboard, mouse, and PS/Xbox game controller with your Phantom-S device.

Chapter 4, *Phantom-S Software*, explains how to use the Phantom-S software, as well as how to create Groups and configuration Profiles.

Chapter 6, *Firmware Upgrade*, explains how to download the firmware upgrade utility and install updates on the Phantom-S.

An Appendix, provides specifications, troubleshooting, and other technical information regarding the Phantom-S.

Conventions

This manual uses the following conventions:

- Monospaced Indicates text that you should key in.
- [] Indicates keys you should press. For example, [Enter] means to press the **Enter** key. If keys need to be chorded, they appear together in the same bracket with a plus sign between them: [Ctrl+Alt].
- 1. Numbered lists represent procedures with sequential steps.
- Indicates selecting the option (on a menu or dialog box, for example), that comes next. For example, Start → Run means to open the *Start* menu, and then select *Run*.
-  Indicates critical information.

Product Information

For information about all ATEN products and how they can help you connect without limits, visit ATEN on the Web or contact an ATEN Authorized Reseller. Visit ATEN on the Web for a list of locations and telephone numbers:

| | |
|---------------|---|
| International | http://www.aten.com |
| North America | http://www.aten-usa.com |

Chapter 1

Introduction

Overview

The Phantom-S is a USB Gamepad Emulator that allows you to use a keyboard and mouse with a PS/Xbox game console. The Phantom-S can be connected to your PS/Xbox and used straight out of the box. The Phantom-S has an easy to use software interface that allows you to customize all game controller buttons for use on a keyboard and mouse. Advanced features allow you to custom map keys, create macros, set turbo buttons, and adjust the sensitivity of movements. Quick macro setup allows up to 8 button combinations - set to one key.

Easy setup- simply click the *on-screen* controller button, press a key to use and its set for use on the keyboard. The Phantom-S allows you to map, set controller sensitivity and switches profiles directly from the keyboard, and alerts you with a beep.

With the Phantom-S you can create an unlimited number of keyboard and mouse configuration profiles - each suited for specific game play. Profiles can be switched and configured during game play for quick access. The Phantom-S gives gamers the ability to customize and fine tune all controls for the expert advantage with every game.

The Phantom-S allows you to:

- ◆ Use a keyboard and mouse on a PS and Xbox game consoles
- ◆ Customize all Gamepad Controls for use on a keyboard and mouse
- ◆ Create custom keyboard/mouse profiles for different games
- ◆ Quickly setup controller buttons on-screen or in-hand
- ◆ Simultaneously use a keyboard, mouse, and PS/Xbox controller
- ◆ Map controls directly from the keyboard and controller
- ◆ Plug and Play - no software required

Features

- ◆ Gamepad Emulation transforms keyboard and mouse signals into game controller signals for keyboard and mouse use on a PS and Xbox game consoles
- ◆ Easy gamepad to keyboard key mapping and advanced configuration via GUI based software
- ◆ Macro editor allows for detailed configuration and command sequence control of a gamepads controller buttons
- ◆ Macros can combine up to 8 controller commands into a single key
- ◆ Supports direct configuration and control from a laptop's keyboard
- ◆ Hot Swap between the PS*/Xbox controller and keyboard/mouse instantly
- ◆ Gamepad and Keyboard mode allow you to instantly switch between typing and gameplay
- ◆ Non-Powerered – No need to use an additional power supply while connected to a game console
- ◆ Phantom-S software supports: Windows 2000, Windows XP, Windows Vista, and Windows 7, 8, and 8.1 Operating Systems

Note: The Phantom-S does not support use with PS1, PS2, or the original Xbox consoles.

Requirements

Game Console / Controller

- ◆ 1 PS3, PS4, PS4 Slim, PS4 Pro, Xbox 360, Xbox One or Xbox One S Console
- ◆ 1 Wired Game Controller

| USB Cable to Connect Controller to Phantom-S | | |
|--|--|---|
| Xbox One | Micro USB Cable | Requires separate cable purchase. |
| Xbox 360 | Original Xbox 360 wired controller supported | Use original Xbox 360 controller cable. (Wireless Play and Charge kit is not supported) |
| Play Station 3 | Mini USB Cable (included with game console) | Use USB cable included with the PS3 game console. |
| Play Station 4 | Micro USB Cable (included with game console) | Use USB cable included with the PS4 game console. |

Keyboard and Mouse

- ◆ 1 USB Keyboard
- ◆ 1 USB Mouse

Audio Support

| Supported Headsets | |
|--------------------|--|
| Xbox One | Headset is supported through the original Xbox One controller. |
| Xbox 360 | Wired headset is supported through the original Xbox 360 controller. |
| Play Station 3 | Headset not supported. To use a headset for audio connect a USB audio adapter directly to the PS3. |
| Play Station 4 | Headset not supported. To use a headset for audio connect a USB audio adapter directly to the PS4. |

Operating Systems

Supported operating systems for the Phantom-S software, are shown in the table, below:

| Software Platform | Version |
|-------------------|-------------------------------------|
| Phantom-S | Windows 2000, XP, Vista, 7, 8.1, 10 |

Components

Front View

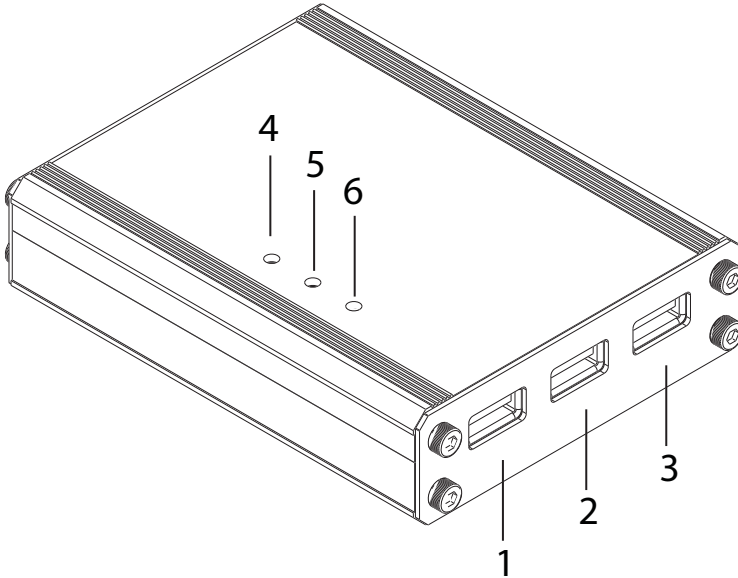

| No. | Component | Description |
|-----|-------------------|---|
| 1 | Gamepad Port | Plug the PS/Xbox game controller into this port. |
| 2 | Keyboard Port | Plug a USB keyboard into this port. |
| 3 | Mouse Port | Plug a USB mouse into this port. |
| 4 | Turbo/KB Mode LED | <ul style="list-style-type: none"> ◆ Lights Orange when Turbo Mode is on. ◆ Flashes Orange when Keyboard Mode is on. |
| 5 | Setting LED | <ul style="list-style-type: none"> ◆ Lights Blue to indicate the Phantom-S software is connected to the device. ◆ Flashes (fast) Blue when uploading a profile from a computer to the Phantom-S. ◆ Flashes (slow) Blue when Direct Mapping mode is on. |
| 6 | Power LED | Lights Blue when the Game Port or Power Port is connected to a power source indicating the unit is on. |

Rear View

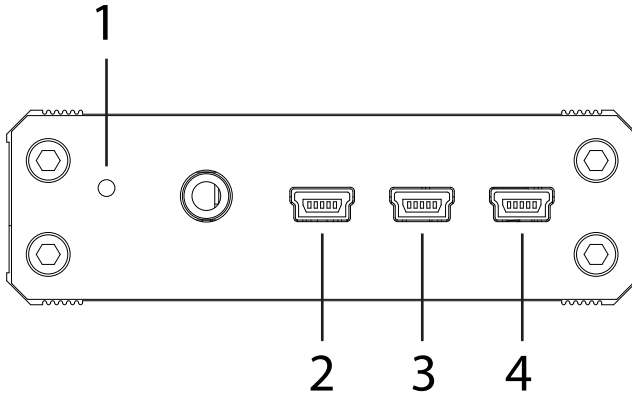

| No. | Component | Description |
|-----|------------|---|
| 1 | Reset | This switch resets the device. Press and release to reset the Phantom-S. |
| 2 | Game Port | The Game Port is used to connect the Phantom-S to a PS or Xbox game console. This port also provides power to the unit when connected to a game console. |
| 3 | PC Port | Use the PC port to connect the Phantom-S to a computer. This connection is used to configure the Phantom-S with the Phantom-S software, or connecting a laptop for game play. Note: The PC Port does not power the unit. |
| 4 | Power Port | This port provides power to the unit. You must use this port for power when connected to a computer; or if you are using an advanced keyboard that requires additional power during gameplay. Use a mini USB to USB cable to connect this port to a 5V power source. |

Getting Started

To begin using the Phantom-S with your PS/Xbox, requires two steps:

1. Connecting Hardware
2. Configuring Mouse Settings

Connecting Hardware

To connect the Phantom-S to a game console use the steps below. To connect the Phantom-S to a computer use steps 7-9 on the next page. To connect to a computer and console simultaneously see *Computer / Laptop + Console Setup*, page 9.

Game Console

NOTE: If a wireless controller is used to power on the PS/Xbox, the game console will not recognize the Phantom-S as a controller. All wireless controllers need to be turned off.

Power off the game console & wireless controllers then use the diagram on page 9 to do the following:

1. Connect a game controller to the **Gamepad** port.
2. Connect a keyboard to the **Keyboard** port.
3. Connect a mouse to the **Mouse** port.
4. Connect the Phantom-S **Game** port to the PS/Xbox **USB port #1** with a mini/micro USB cable.
5. Power on the PS/Xbox from the console*.

Do not use a wireless controller to power on the PS/Xbox console.

6. The Phantom-S is ready for use.

Note: The PS4 controller connected to the Phantom-S should have an **Orange** light bar when the console is powered on. If the light bar is blue – power off the game console & controllers, then repeat the steps above.

Computer

To connect the Phantom-S to a computer and use the Phantom-S software, use the diagram on page 8 and follow the steps below:

7. Use the Mini USB to USB cable included with this package to connect the **PC** port* to a computer.
8. Use a Mini USB to USB cable (not included) to connect the **Power** port* to a computer, or 5V USB power source.
9. Start the Phantom-S software (see *Phantom-S Software*, page 26).

Note: The **PC** and **Power** port must be connected to power the Phantom-S when connected to a computer to use the Phantom-S software.

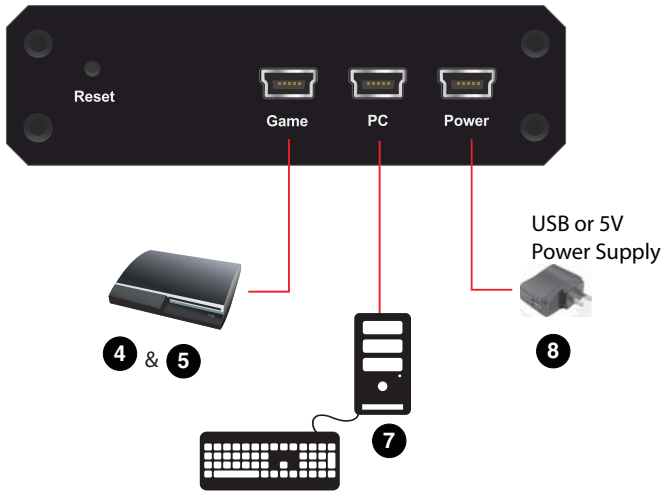
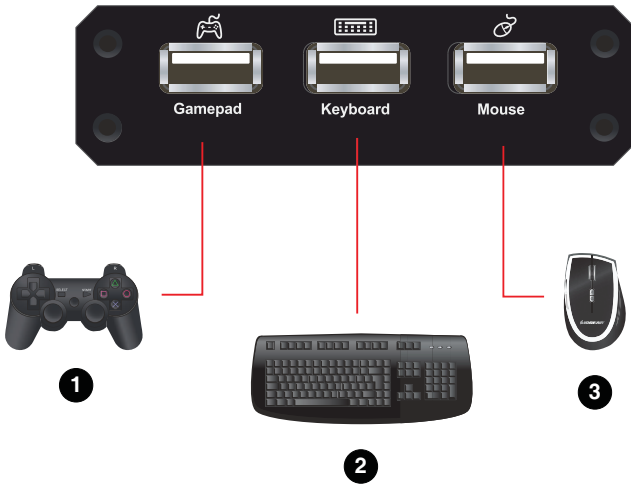

Computer / Laptop + Console Setup

You can connect the Phantom-S to a PC and game console at the same time and switch keyboard use between the two. A computer also allows you to configure settings using the Phantom-S software and quickly switch back to gameplay. Use the diagram and steps to connect a laptop:

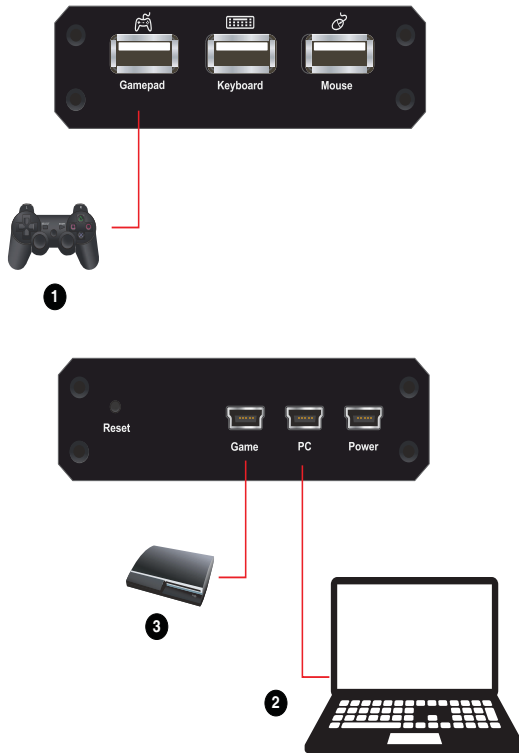

1. Connect a controller to the **Gamepad** port*.
2. Use the Mini USB to USB cable included with this package, to connect the **PC** port to a computer.
3. Use the Mini USB to USB cable included with this package to connect the **Game** port to the PS/Xbox **USB port #1**.
4. Power on all devices*.
5. Press **[F12]** to toggle Playmode (See *Play Mode*, page 25).

Note: All wireless controllers must be powered off and the PS/Xbox must be powered on from the console. See *Game Console*, page 6 for details.

PS4 Remote Play / Xbox Game Streaming

The Phantom-S supports PS4 and Xbox streaming services which allow you to control your game console from a computer. With the PS4/Xbox application installed on a PC, you can connect the Phantom-S and continue gaming while being connected remotely to your game system.

Use the diagram and steps below to setup the Phantom-S for gameplay with a streaming service:

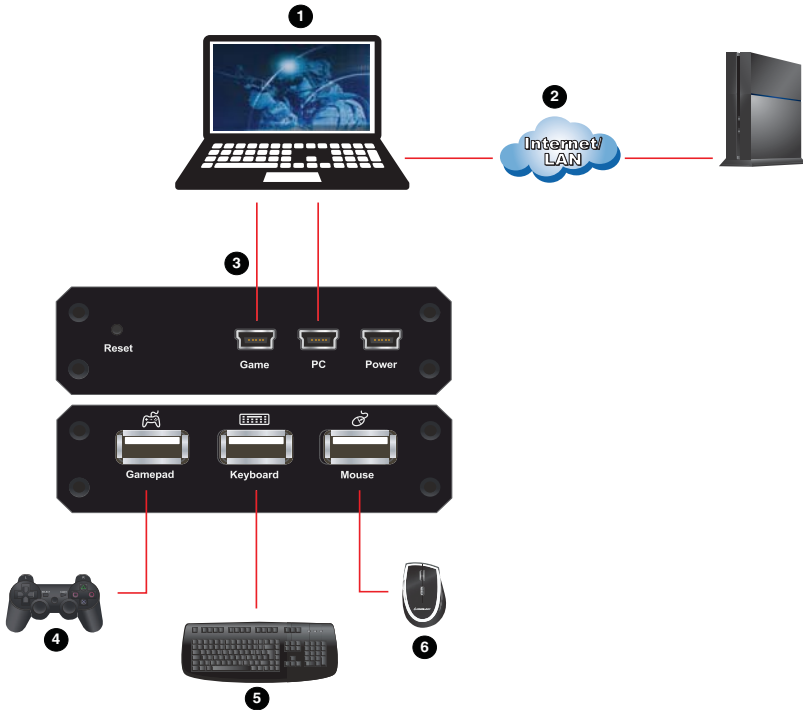

1. Install PS4 Remote Play or Xbox One Streaming and the Phantom-S software on a computer.
2. Log in to the PS4 or Xbox One streaming service and connect to the game console.
3. Use the Mini USB to USB cables included with this package, to connect the **Game** and **PC** ports to the computer.
4. Connect a game controller to the **Gamepad** port.
5. Connect a keyboard to the **Keyboard** port.

6. Connect a mouse to the **Mouse** port.
7. Use the keyboard and mouse connected to the Phantom-S for gameplay.*

Note: For streaming gameplay with the laptop's keyboard/mouse you must use a second monitor in extended display mode and start Playmode [F12] – then you must drag-and-drop the Phantom-S window to the first monitor's screen, as shown below.

Streaming in Playmode [F12]

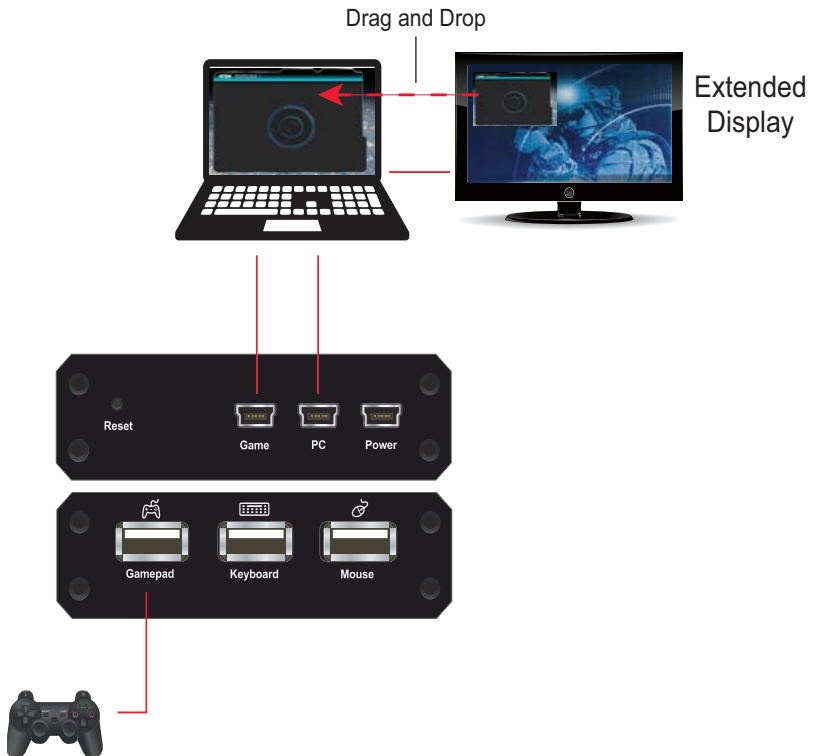

Quick Start Mouse Configuration

Before you begin there are four important settings that need to be set to improve mouse movements within games.

1. Maximize all in-game sensitivity settings of the game that you are playing. **See *Mouse Settings***, page 13.
2. Check the manufacture for your mouse's DPI and set this in the Phantom-S software. **See *Menu***, page 29.
3. Adjust the Deadzone settings for the mouse. **See *Deadzone Delay***, page 21.
4. Adjust the mouse sensitivity to your liking, using the Phantom-S software. **See *Sensitivity***, page 42.

Mouse Settings

If you are using a mouse with software such as Setpoint (*Logitech*), you will need to adjust the DPI (Dots-per-inch) and Report Rate settings for better gameplay. This can only be done with the software utility that came with the mouse.

DPI

If your mouse came with software - use the utility to set the mouse DPI to the highest possible setting. This will allow you to have a greater range of mouse sensitivity when adjusting the controls with the Phantom-S software.

If there is an adjustable DPI button on your mouse, be sure to set the maximum DPI setting (using the DPI button) every time it's plugged into the Phantom-S.

Report Rate

The report rate sets how often the computer requests the current position and button values of the mouse. Use the software utility that came with your mouse to set the report rate to its highest setting. The report rate is typically 125~1000. You can start with the highest setting and adjust accordingly to what feels best when using your mouse on the PS/Xbox game console with the Phantom-S.

Note: Check each game's "Sensitivity" settings to ensure it is set to the maximum level to get the greatest range of adjustment with the Phantom-S.

Chapter 3

Basic Operation

Overview

This chapter explains how to use a keyboard and mouse for gameplay and how to configure basic modes from the keyboard and controller. For information on mapping, profiles and advanced settings, see Chapter 4.

Basic Operation

This section explains how to use the keyboard and mouse with the PS/Xbox game console. Once the hardware is connected the keyboard, mouse and controller will work on the game console. Here is how the controller is mapped to the keyboard and mouse:

Mouse Map

The mouse is used for up/down and right/left movements, just like the **Right Stick** control, as shown below:

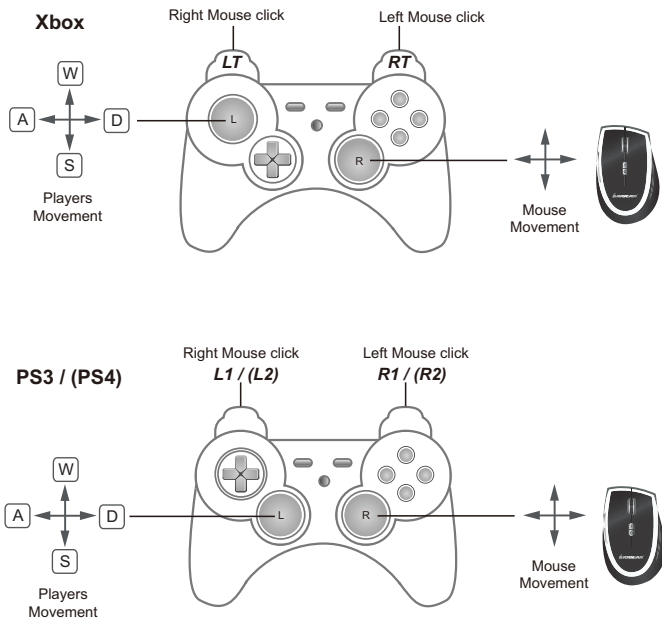

Keyboard Map

The controller buttons and directional pads are mapped to the keyboard, as shown here:

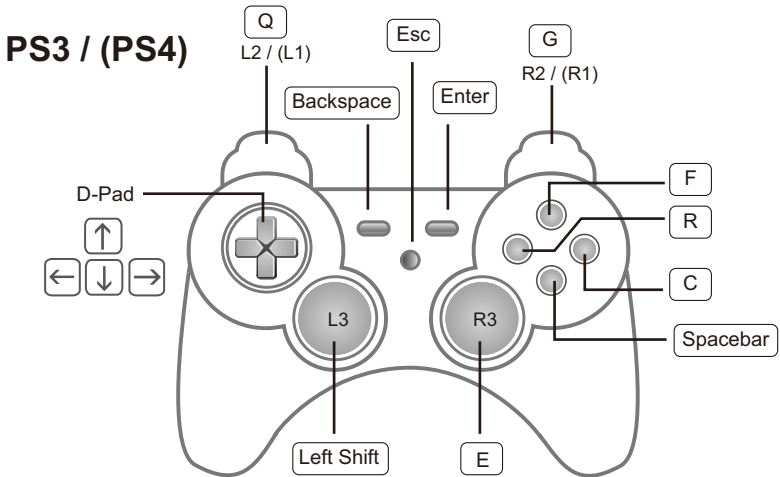
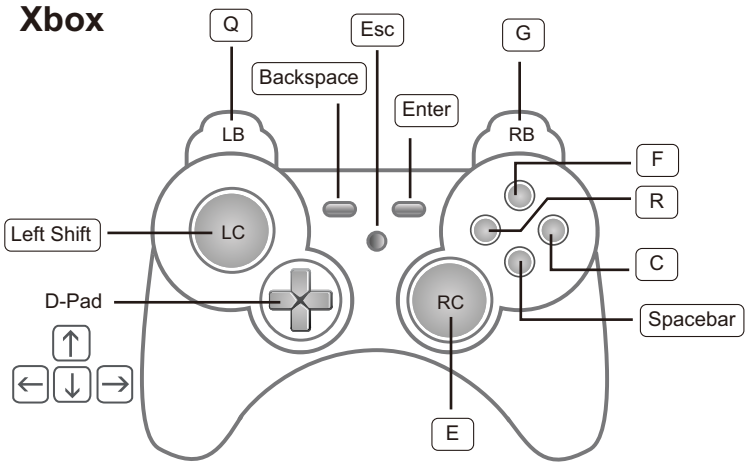

Function Keys & Caps Lock

The function keys on the keyboard enable *modes*, *switch profiles* and *map keys* without the Phantom-S software. The table below explains each function key and provides a page with information on how it's used.

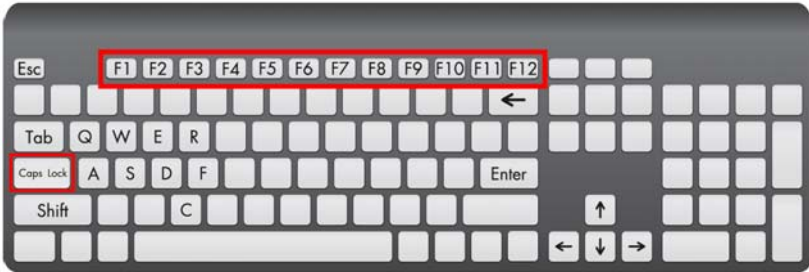

| Hotkey | Function | Description | Page |
|-------------|-------------------------|--|------|
| [F1] ~ [F8] | Switch Profile | Switches to the Profile in the Current group set with the <i>Profile Selection Hotkey</i> that was pressed. Default Controller Profiles: [F1]: PS3 [F2]: Xbox 360 [F3]: Xbox One [F4]: PS4 | 24 |
| [F9] | Keyboard / Gamepad Mode | Toggles between Keyboard and Gamepad Mode. Keyboard Mode: Allows you to type text during gameplay. Gamepad Mode: Allows you to use the keyboard as a controller on the game console. | 24 |
| [F10] | Turbo Mode | Toggles Turbo Mode on and off. When Turbo mode is on buttons with Turbo settings will work. See <i>Turbo</i> , page 40, for details on Turbo settings. Note: Turbo settings only work on the keyboard and mouse. Turbo settings will not work from the game controller. | 24 |
| [F11] | Macro Mode | Turns Macro Mode on and off. When on, Macro keys will execute macro commands. See <i>Macro Settings</i> , page 54, for details on setting macros. | 25 |
| [F12] | Play Mode | Play Mode allows you to use a keyboard and mouse connected to a PC for gameplay. | 25 |

| | | | |
|---|---------------------------|---|----|
| (PS3 Controller) Select + Start - (PS4 Controller) Share + Option - (Xbox Controller) Back + Start | Mouse Sensitivity | This allows you to adjust the Aim/Look and ADS sensitivity of the mouse during game play. | 20 |
| (PS3 Controller) Select + Start & PS Button - (PS4 Controller) Share + Option & PS Button - (Xbox Controller) Back + Start & Xbox Guide Button | Direct Mapping Mode | Direct Mapping allows you to set the controller to keyboard mappings from the game controller and keyboard, so you don't have to use the Phantom-S software. | 19 |
| Caps Lock | Walk Mode | During gameplay, to move a character at slow walking pace, use the keyboard combination: Caps Lock + [Key] . | - |

Direct Configuration

You can map keyboard controls, enable game modes and adjust mouse sensitivity settings from the keyboard and game controller. This allows you to change settings without the Phantom-S software. Each control is explained in detail starting on the next page.

Beeps

The Phantom-S beeps when you make changes from the keyboard and game controller. Beeps let you know if settings are changed and when functions turn on and off. To turn beeps off see *Menu*, page 29 - *Beep Sound*.

Single Beep is a positive reply, meaning that a change is successful or that a mode has been turned on.

Double Beep is a negative reply, meaning a setting has reached its limit, a mode was turned off or a mode was exited.

Direct Mapping Mode

Direct Mapping allows you to change the controller button to keyboard mappings - using the controller and keyboard. For example, you can map controller button **A** to the spacebar on the keyboard.

To use Direct Mapping Mode from the controller connected to the Phantom-S:

1. Press **Select + Start** (PS3), **Share + Option** (PS4) or **Back + Start** (Xbox) at the same time.

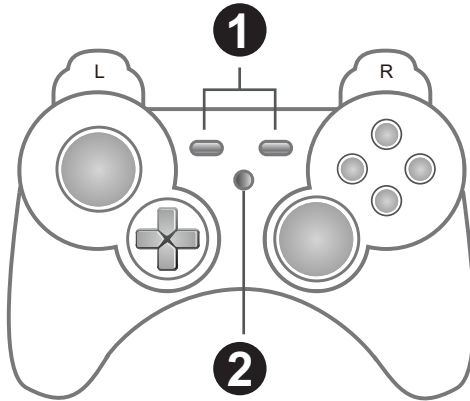

2. Press the **PS** or **Xbox Guide** Button.
3. Press a button on the game controller.
4. Press a key on the keyboard to map the controller button.
5. Continue mapping buttons by repeating steps 3-4.
6. Press **Select + Start** (PS3), **Share + Option** (PS4) or **Back + Start** (Xbox) to exit Direct Mapping Mode.

Note: Direct Mapping changes are not permanently saved to a Profile.

Mouse Sensitivity Mode

Mouse Sensitivity Mode allows you to change the *Aim/Look* and *ADS* sensitivity for mouse movements - using the game controller. For information about mouse sensitivity see *Sensitivity*, page 42.

To enter Mouse Sensitivity mode:

To use Mouse Sensitivity Mode from the controller connected to the Phantom-S:

1. Press **Select + Start** (PS3), **Share + Option** (PS4) or **Back + Start** (Xbox) at the same time.

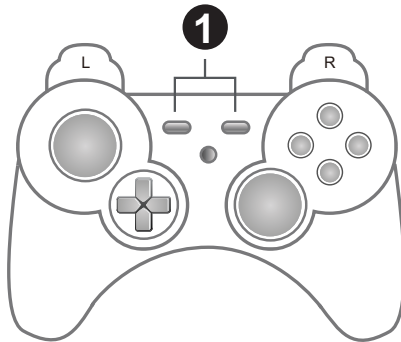

2. To adjust **Aim/Look** sensitivity - use the **Direction Up** (more sensitive) or **Direction Down** (less sensitive) pad on the game controller.



3. To adjust **ADS** sensitivity - use the **Direction Left** (more sensitive) or **Direction Right** (less sensitive) pad on the game controller.



4. Press **Select + Start** (PS3), **Share + Option** (PS4) or **Back + Start** (Xbox) at the same time to exit Mouse Sensitivity Mode.

Note: These changes are not permanently saved to a Profile.

Deadzone Delay

The Deadzone is a small area around the *Right Stick* control that doesn't respond to movement. Movement only occurs when the *Right Stick* moves outside the Deadzone. Each game sets its own Deadzone size. With no Deadzone there is no delay with the mouse and movements are very straight and accurate.

Right Stick Deadzone

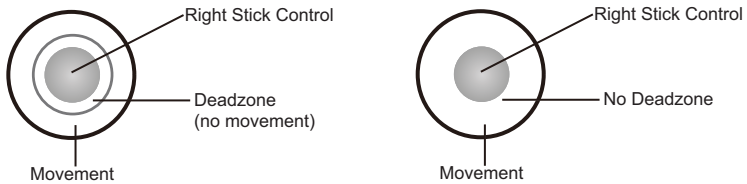

Set all 3 Deadzones for the best mouse performance. The Deadzone must be set while playing a first person shooter (FPS) game. The Deadzone is set when—after the last adjustment (step 3) the player starts to slowly move on-screen.

To set the **Right/Left** Deadzone:

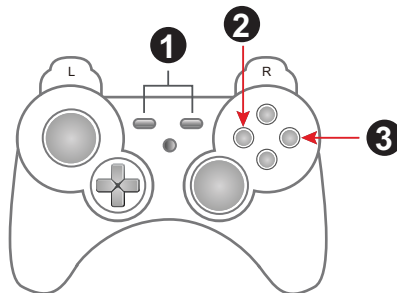

1. From the game controller connected to the Phantom-S, press **Select + Start** (PS3), **Share + Option** (PS4) or **Back + Start** (Xbox) at the same time.
2. Press the **Square** (PS) or **X** (Xbox) button for right/left adjustment.
3. Repeatedly press **O** (PS) or **B** (Xbox) until you see a slow right movement on screen = no dead zone. (**X** or **A** to increase Deadzone)
4. Press the **Square** or **X** button to save.

- Repeat step 1 to exit, or skip step 5 and continue with the next Deadzone settings without exiting.

To set the **Up/Down** Deadzone:

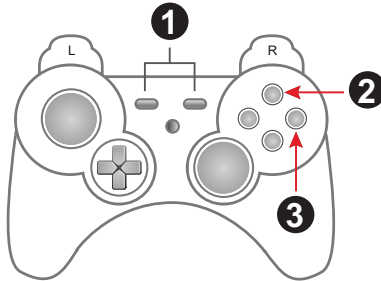

- Press **Select + Start** (PS3), **Share + Option** (PS4) or **Back + Start** (Xbox) at the same time.
- Press the **Triangle** (PS) or **Y** (Xbox) button for up/down adjustment.
- Repeatedly press **O** (PS) or **B** (Xbox) until you see a slow up movement on screen = no dead zone. (**X** or **A** to increase Deadzone)
- Press the **Triangle** or **Y** button to save.
- Repeat step 1 to exit.

To set the **Diagonal** Deadzone:

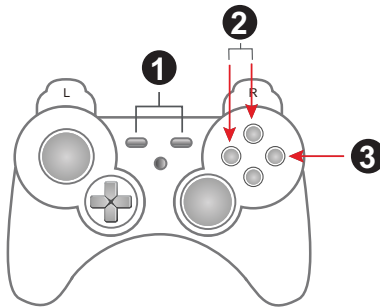

- Press **Select + Start** (PS3), **Share + Option** (PS4) or **Back + Start** (Xbox) at the same time.
- Press the **Triangle** and **Square** (PS) or **X** and **Y** (Xbox) buttons for diagonal adjustment.
- Repeatedly press **O** (PS) or **B** (Xbox) until you see a diagonal up movement on screen = no dead zone. (**X** or **A** to increase Deadzone)

4. Press the **Square + Triangle** (PS) or **X + Y** (Xbox) button to save.
5. Repeat step 1 to exit.

Testing the Deadzone

Test the mouse within the first-person shooter game. Movements will be smooth, stable and accurate. You'll also notice that shooting becomes more steady and reliable than with the game controller. If any mouse movements are shaky or jumpy repeat the steps to set the Deadzone. With the Deadzone set the mouse performance should be excellent. You can also set the Deadzone using the Phantom-S software (see page 51).

Decrease Deadzone

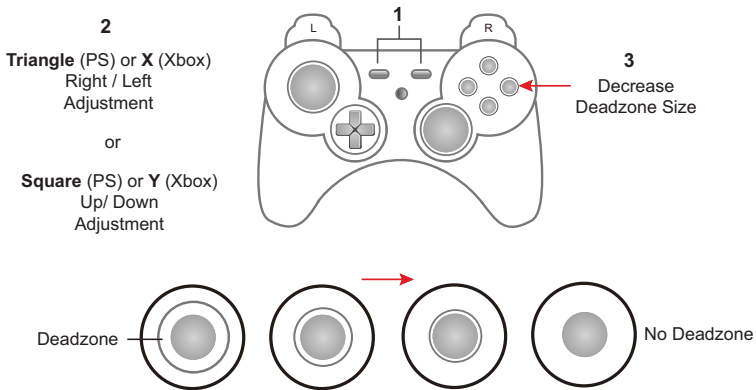

Increase Deadzone

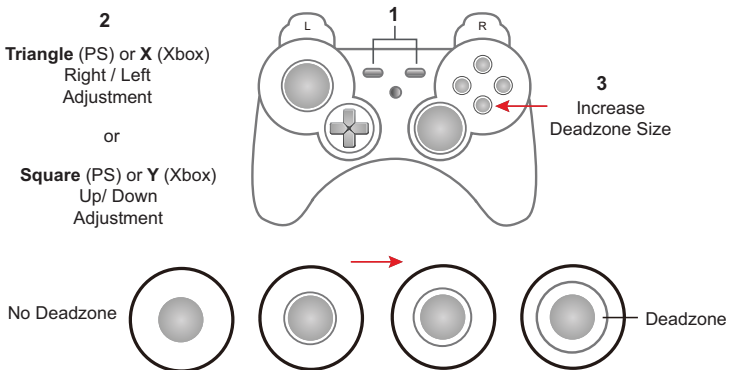

Profile Selection

Profile Selection Hotkeys are assigned to profiles when they are created (see *Adding Profiles*, page 34). You can switch to a profile in the Current group during gameplay using the *Profile Selection Hotkey* assigned to it. The *Profile Selection Hotkey* is found on the top left corner of each profile, as shown here:



To switch profiles, press the *Profile Selection Hotkey* assigned to the profile. A single beep will alert you that the profile has changed. **[F1]**: Default PS Controller Profile. **[F2]**: Default Xbox Controller Profile.

To select to a profile, press the *Profile Selection Hotkey* **[F1]** to **[F8]**. A single beep will alert you that the profile has switched.

Keyboard / Gamepad Mode

Keyboard Mode allows you to use the keyboard to type during gameplay - for chatting or typing in information that requires text. **Gamepad Mode** is for normal gameplay with the keyboard.

Press **[F9]** to toggle between Keyboard Mode and Gamepad Mode.

Single Beep - Keyboard Mode on / Gamepad Mode off

Double Beep - Keyboard Mode off / Gamepad Mode on

Turbo Mode

With **Turbo** on all turbo setting set for the keyboard and mouse* will work (see *Turbo*, page 40). The orange Turbo LED lights up.

Press **[F10]** to toggle Turbo Mode on and off.

Single Beep - Turbo Mode on

Double Beep - Turbo Mode off

Note: Turbo settings only work on the keyboard and mouse. Turbo settings will not work from the game controller.

Macro Mode

With **Macro Mode** on macros will execute when the key is pressed (see *Macro Mode*, page 25). By default Macro mode is off.

Press [F11] to toggle Macro Mode on and off.

Single Beep - Macro Mode on

Double Beep - Macro Mode off

Play Mode

Play Mode allows you to toggle use of a computer or laptop keyboard and mouse for gameplay. For instructions to setup a PC for Playmode see *Computer / Laptop + Console Setup*, page 9.

With **Play Mode** on, keyboard and mouse use on the computer is locked and the keyboard and mouse signals are sent to the game console for gameplay. By default Play Mode is off.

Press [F12] to toggle Play Mode on and off.

Single Beep - Play Mode on

Double Beep - Play Mode off

Note: With Play Mode on you can use a keyboard connected to the Phantom-S's Keyboard Port, but it's [F12] key will not turn Play Mode off.

Chapter 4

Phantom-S Software

Overview

The Phantom-S software allows you to configure the keyboard and mouse settings for game console use. This chapter explains how to use the software in four sections:

- ◆ Downloading & Connecting
- ◆ Software Overview
- ◆ Groups, Profiles and Upload
- ◆ Customizing Controls

Downloading

To download the Phantom-S software, do the following:

1. Go to www.aten.com/phantoms
2. Follow the instructions to download the Phantom-S software.
3. Save and unzip the file to your hard drive.
4. Double click the *Phantom-SR_.exe* and the software opens:



Connecting the Phantom-S Software

To connect the Phantom-S software to the Phantom-S:

1. Connect the Phantom-S to a computer.
2. Open the Phantom-S software. The connection page opens:



If the Ready image doesn't appear see *Connecting Hardware*, page 6.

3. Click **Ready**.



4. The Phantom-S software opens as shown on the next page.

Phantom-S Interface

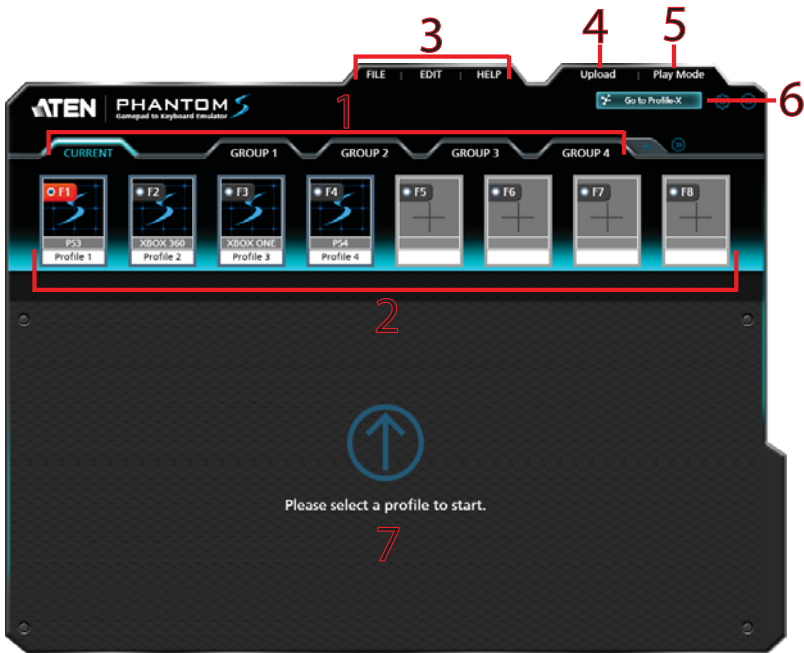

This is the main page of the Phantom-S software. The table below provides a brief description of each section and the page to find more information.

| # | Name | Description | Page |
|---|-----------------------|--|------|
| 1 | Groups | <p>This bar lists and allows you to add Groups.</p> <ul style="list-style-type: none"> ◆ A Group stores up to 8 profiles. ◆ Current is the group of profiles on the Phantom-S. ◆ A Group is Uploaded to Current. ◆ Only profiles in Current can be selected for use. | 32 |
| 2 | Profile Selection Bar | <p>This section is where you add profiles. A Profile is a configuration that saves the settings and maps the controller buttons for the keyboard and mouse</p> <ul style="list-style-type: none"> ◆ Profiles are created and saved in a Group. ◆ A Group of profiles is uploaded to Current. ◆ Only profiles in Current can be selected for use. | 33 |

| # | Name | Description | Page |
|---|------|---|------|
| 3 | Menu | <p>Click the File, Edit or Help menu to display the options:</p> <p>File</p> <ul style="list-style-type: none"> ◆ <i>Save</i>: Saves the profile that is being configured. ◆ <i>Save as</i>: Use the drop-down menus to select a Group and Profile to save the current profile. ◆ <i>Import</i>: Use Profile to import a previously saved profile file (*.profile). Use Group to import a previously saved group file (*.group). ◆ <i>Export</i>: Use Profile to save a profile as a file (*.profile) that can be imported. Use Group to save a group as a file (*.group) that can be imported. ◆ <i>Exit</i>: Closes the Phantom-S software. <p>Edit</p> <ul style="list-style-type: none"> ◆ <i>Delete</i>: Use Profile or Group to permanently remove either from the system. ◆ <i>Rename</i>: Select a profile and click rename to edit the profile name. ◆ <i>Change Cover</i>: Use to browse and select an image for the current profile's icon. ◆ <i>Copy</i>: Use Profile to copy the selected profile and paste it in another group. Group creates a copy of the selected group as a new group. ◆ <i>Paste</i>: Select a profile slot to Paste a copied profile from one group into another. <p>Help</p> <ul style="list-style-type: none"> ◆ <i>Firmware Upgrade</i>: Browse to select the upgrade file and click Open to start the process. <p>Settings</p> <ul style="list-style-type: none"> ◆ <i>Keyboard Setting</i>: Select the type of keyboard connected for use. (default: US 104-Key) ◆ <i>Menu Language</i>: Select the language you would like to use for the software interface. ◆ <i>Beep Sound</i>: Select On to sound a beep when a configuration change is made via keyboard or controller. Single Beep: Successful. Double Beep: unsuccessful. ◆ <i>Set Mouse DPI</i>: Enter the number that matches the DPI specifications of the mouse connected to the Phantom-S. (default: 2000) ◆ <i>View Button Mappings at start up</i>: Select On to view button mappings when you select a profile. ◆ <i>Reset to Factory Default</i>: Resets all software settings. | N/A |

| # | Name | Description | Page |
|---|-----------------|---|------|
| 4 | Upload | <p>Click this button to upload the selected Group (of profiles) to Current for use. This uploads the group of profiles you want to use to the Phantom-S.</p> <ul style="list-style-type: none">◆ When you Upload a group it over-writes all profiles in Current.◆ Profiles in Current can be selected for use on the keyboard and mouse during game play.◆ You can edit Current profiles but changes are not saved and if a group is uploaded, all changes are lost. | 35 |
| 5 | Play Mode | <p>Play Mode is used when you connect a computer and game console to the Phantom-S – at the same time.</p> <p>When using a laptop or computer's keyboard and mouse, click Play Mode to send all keyboard/mouse signals to the PS/Xbox for gameplay.</p> <ul style="list-style-type: none">◆ In Playmode the keyboard/mouse won't work on the PC.◆ Press [F12] to exit Play Mode.◆ See <i>Play Mode</i>, page 25, for details. | 9 |
| 6 | Go to Profile-X | <p>Click this button to log in to the Profile-X web portal where you can post, share and request Phantom-S content with other gamers.</p> | 59 |
| 7 | Profile Editor | <p>This is the main area where customize the controls for the keyboard and mouse. Items appear when you select or add a profile.</p> | 37 |

Software Overview

This section provides an overview of how to use the Phantom-S software. The sections that follow provide details on each step. Connect the Phantom-S to a computer and do the following:

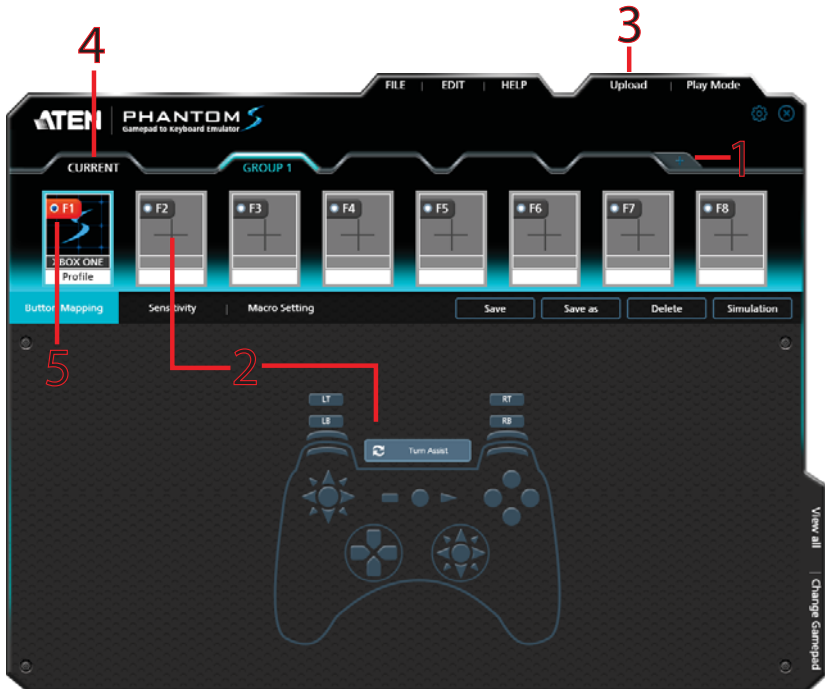

1. Add a **Group**.
2. Add **Profiles** to the group.
3. **Upload** the group to Current.
4. Go to the **Current** tab.
5. Use the *Profile Selection Radio Button* to set a profile (turns red) as the default start-up profile.
6. Connect the Phantom-S to the game console / keyboard / mouse.
7. The keyboard/mouse is ready for use with the profile set in step 5.
8. Press a *Profile Selection Hotkey* [F1]~[F8] to switch profiles from the keyboard. Profiles in **Current** are selected for use.

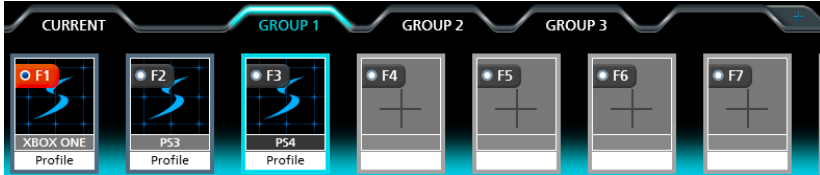

Groups

The Group bar is for selecting and adding groups. You can create up to 32 groups. You can add up to 8 profiles with keyboard/mouse settings to a group. Upload a group to Current and the profiles can be selected for use.



- ◆ Click  to add a new group.
- ◆ Click  to scroll to view more groups.
- ◆ Click a group (Group 1, Group 2, Group 3, etc.) to add profiles.
- ◆ Click **Upload** to send the group to **Current**.
- ◆ When a group is uploaded it over-writes all profiles in Current.
- ◆ Profiles changed in Current are not saved back to the group in which they were created.
- ◆ Only the Group (of profiles) uploaded to **Current** can be selected by using the *Profile Selection Hotkey* (F1~F8).

Profiles

The *Profile Selection Bar* is for adding and configuring profiles in a group. A **Profile** is a keyboard/mouse configuration that is created and saved in a **Group**. Each profile has custom settings for a keyboard and mouse. Only the Group (of profiles) uploaded to **Current** can be selected for use.

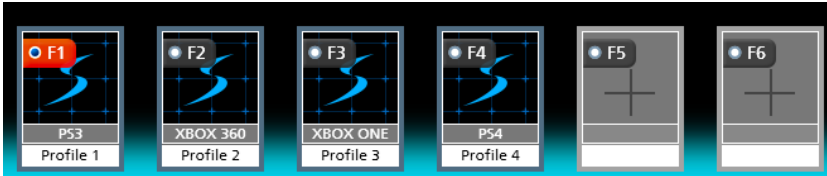

- ◆ **Profile Selection Hotkey:** Each profile has a hotkey [F1]~[F8] to select it for use from the keyboard connected to the Phantom-S during gameplay.
- ◆ **Start-up Profile:** Click the radio button  next to the Profile Selection Hotkey to set a profile as the default start-up profile for the group.
- ◆ The **grey** box displays the controller type and the **white** box displays the name.
- ◆ To edit a profile, **Right Click:**



For details on these menu options see *Menu*, page 29 - **Edit**.

Adding Profiles

To create a new profile for your keyboard/mouse settings:

1. Select a **Group** and click an empty profile slot:

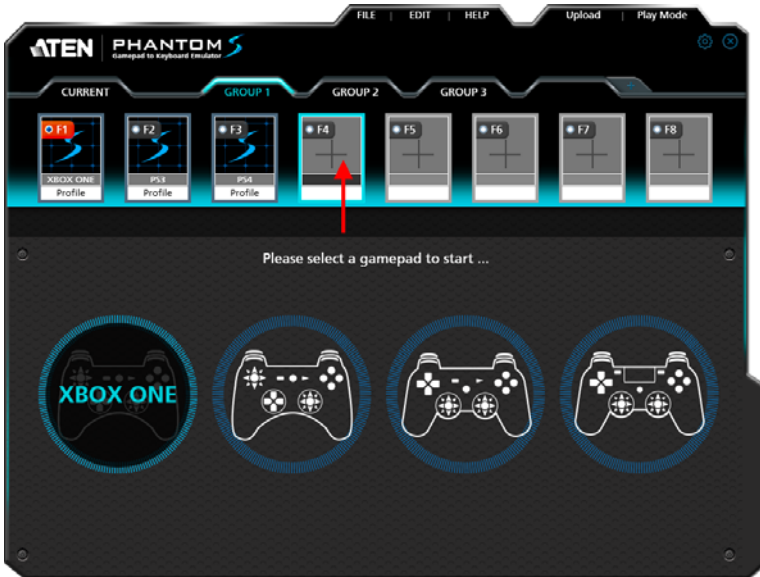

2. Select the gamepad you are using.
3. The *Profile Editor* appears to configure the keyboard and mouse settings and the new profile is added to the **Profile Selection Bar**.



Note: The *Profile Editor* is discussed on page 37.

Upload

A Group (of profiles) needs to be uploaded to **Current**. Only the profiles in Current can be selected for use. You can view and edit profiles in Current but the changes are not saved back to the Group. When a group is uploaded to Current it over-writes all profiles. You can select **Copy - Group** from the *Edit* menu to save Current as a group.

To **Upload** a group, do the following:

1. Select a **Group** and click **Upload**.

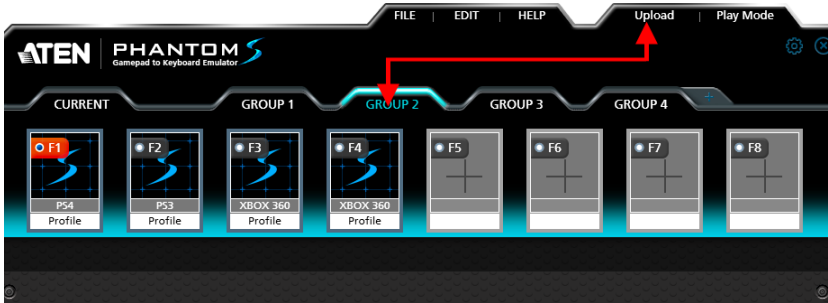

2. A confirmation messages appears. Click **OK**.

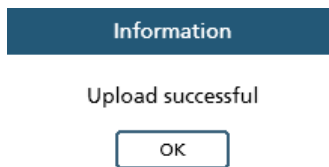

3. Go to the **Current** tab.
4. The Group is sent to **Current** and is marked with a star, as shown here:

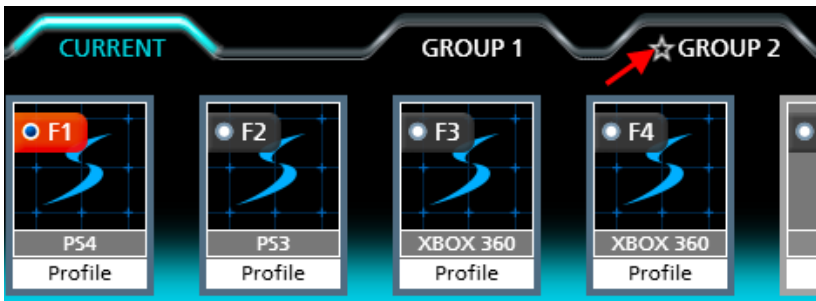

5. Use the **Radio Button** to set the default start-up profile (turns red). This is the default profile that will be selected for use when the Phantom-S is connected to the game console

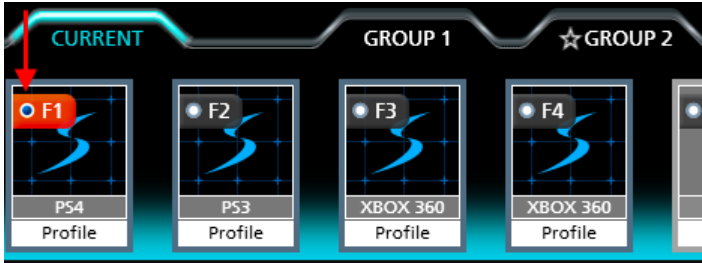

Customizing Controls

This section explains how to use the *Profile Editor* to configure the keyboard/mouse settings. When you select a profile from the Profile Selection Bar the *Profile Editor* opens on the Button Mapping screen:

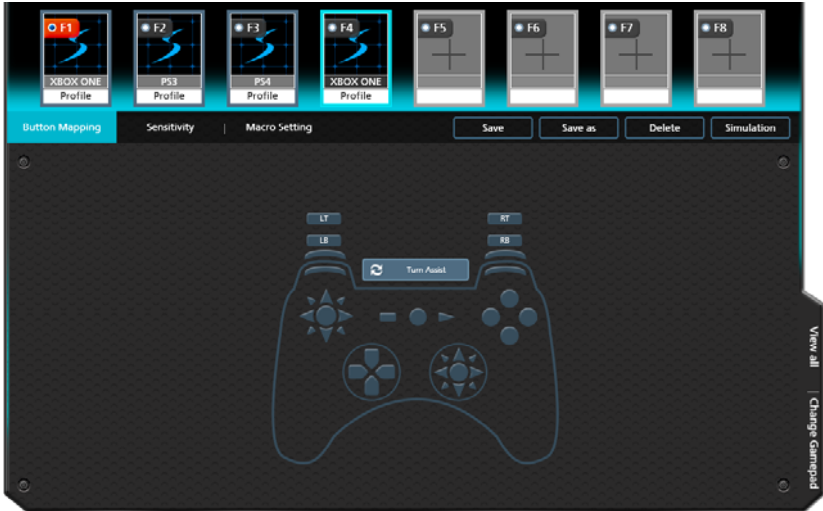

| Name | Details | Page |
|----------------|---|------|
| Button Mapping | The Button Mapping page is for mapping the game controller buttons to the keyboard and mouse. | 38 |
| Sensitivity | The Sensitivity page is used to configure the mouse sensitivity settings for Aim Look Mode and ADS Mode (Aim-Down-Sight). | 57 |
| Macro Settings | The Macro Settings page is used to create controller button macros which can be executed from a keyboard, mouse, or joystick. | 54 |
| Menu Options | Click to use the Menu options: <ul style="list-style-type: none"> ◆ Save: Saves changes made to this Profile. ◆ Save as: Saves profile changes to a new group and profile. ◆ Delete: Permanently deletes the profile from the group. ◆ Simulation: Use this option to test changes you make to a profile on the game console. Press [F12] to exit. | N/A |

Button Mapping

The *Button Mapping* screen is for mapping the controller buttons to the keyboard and mouse, setting Turbo and Turn Assist. When you select a profile from the Profile Selection Bar, the Button Mapping image appears:

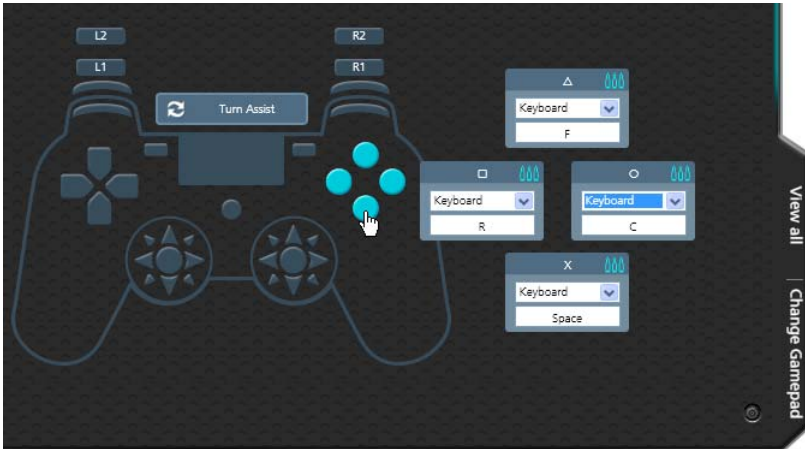

- ◆ Click a set of buttons or the touchpad to open the editor windows and set the mappings.
- ◆ **View All:** Click to view all controller button mappings.
- ◆ **Change Gamepad:** Click to change the gamepad type. A window opens with a drop-down menu to select a controller type. Some settings might change if the controller has different buttons.
- ◆ For default button mappings, see *Keyboard Map*, page 15.
- ◆ For *Mapping*, see page 39.
- ◆ To set *Turbo*, see page 40.
- ◆ To set *Turn Assist*, see page 41.

Mapping

Each controller button can be mapped to a keyboard, mouse or joystick. When you click a button set the editor windows open:

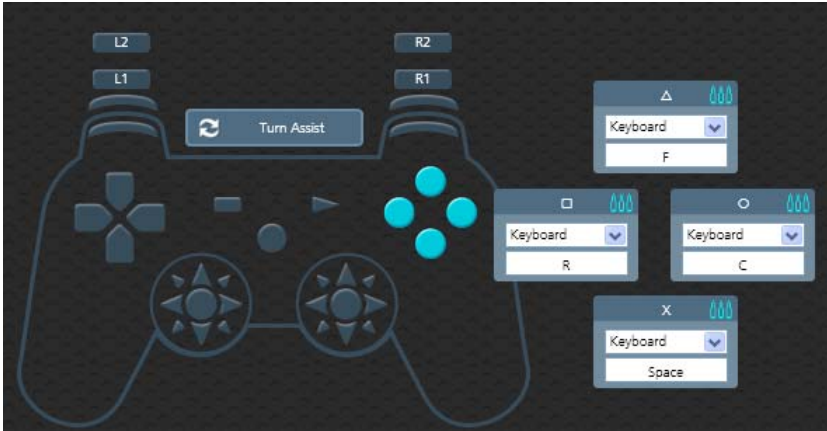

To map a controller button:

1. Use the drop-down menu to select a device and then the key or button:

Keyboard: Click inside the box and press a key on the keyboard to map the controller button to a key.

Mouse: Use the drop-down menu to select a mouse button to map the controller button to.

Joystick: Use the drop-down menu to select a button to map the controller button to.

None: This option disables the controller button's mapping.

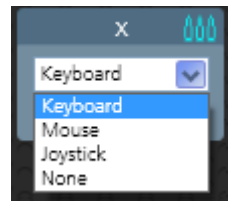

2. Click **Save** to save the profile mappings.

Note: When mapping the controller's analog sticks, click on the white controller icon to change emulation to the right/left stick.

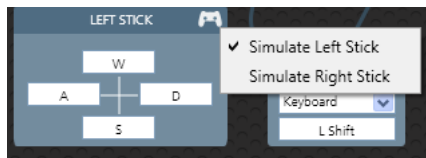

Turbo

Turbo allows rapid fire of a button from the keyboard and mouse. You can enable or disable turbo for any controller button* and set the level (1~3) of intensity. *Turbo Mode* must be on for turbo buttons to work (see *Turbo Mode*, page 24).

To set turbo on a button:

1. Click a button set to open the editor windows.
2. Click the top bar of the editor window to set the turbo level. A bullet icon will appear for each level.

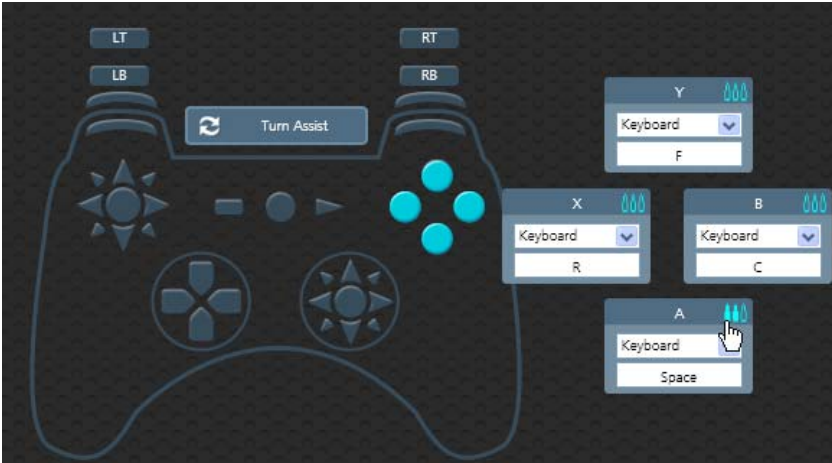

3. Set the level (1~3) of rapid fire you want to use:

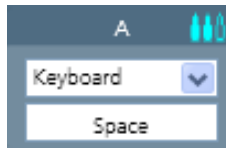

3 Empty Bullets = Turbo Off.

4. Click **Save**.

Note: Turbo settings only work on the keyboard and mouse. Turbo settings will not work from the game controller.

Turn Assist

Turn Assist helps you continue long mouse movements without having to move the mouse. Turn Assist works by holding down the Turn Assist **Button** while moving the mouse. The turn continues automatically until you let go of the turn assist button. Select a device and assign the turn assist **Button** and then click **Save**.

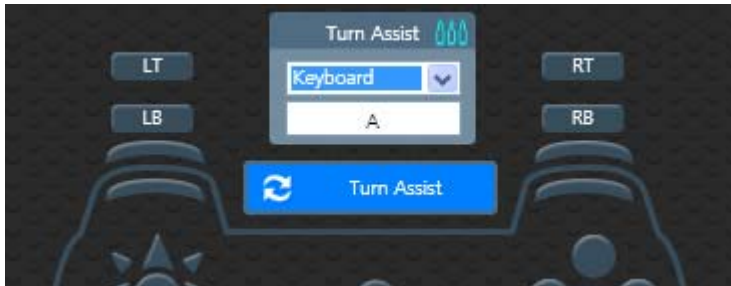

| Device | Turn Assist Button |
|----------|---|
| Keyboard | Enter a key you want to use as the Turn Assist button. |
| Mouse | Select a Mouse function to use as the Turn Assist button. |
| Joystick | Select a button 1~12 to use as the Turn Assist button. |
| None | No Turn Assist device assigned. |

Sensitivity

The *Sensitivity* section is for configuring the sensitivity of mouse movements. You can set the mouse sensitivity for **Aim Look Mode**: the normal view the character has walking around in the game, or **ADS (Aim-Down-Sight) Mode**: the view the character has when zooming-in to look through a scope. Instructions are provided beginning on the next page.

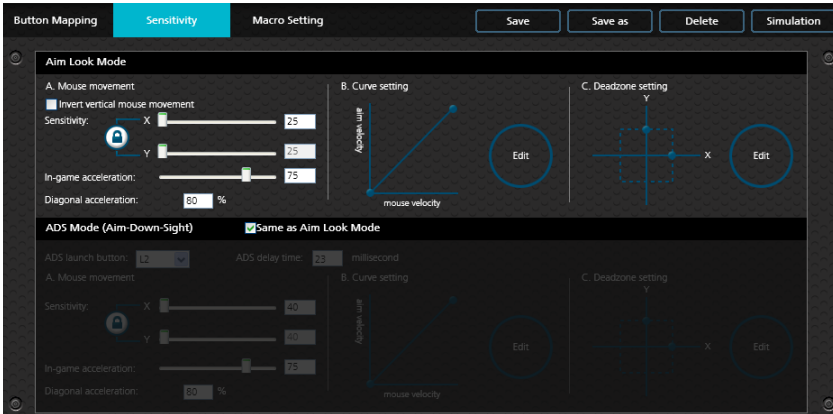

Aim Look Mode

These settings configure how the mouse movements respond during when the character has a normal view in the game (not zoomed in).

A. Mouse Movement

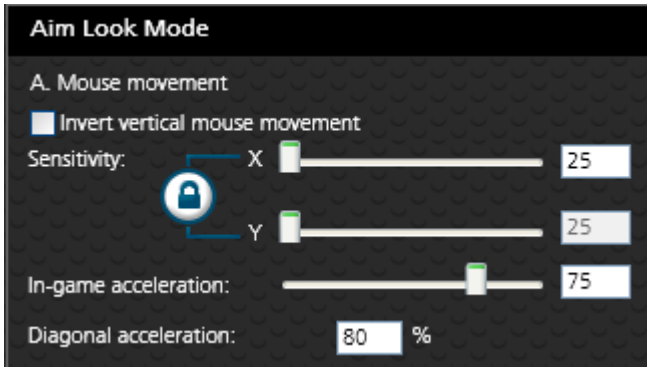

| Name | Details |
|---|--|
| Invert Vertical Mouse Movement | Checking the box reverses the up/down movements of the mouse, so that pushing the mouse forward causes a downward movement and pulling the mouse back causes an upward movement. |
| Sensitivity | The Aim Look sensitivity bar sets how quick or slow mouse movements respond. The higher the number the more loose the movements will feel and the lower the number the more tight the movements will feel. <ul style="list-style-type: none"> ◆ Use X to set the sensitivity of right and left movements ◆ Use Y to set the sensitivity of up and down movements |
| Lock  | The lock icon is used to fix the X and Y settings so that both stay the same. Click the icon to unlock the settings and set each to different values. |
| In-game Acceleration | Sets the level of acceleration mouse movements make as they continue moving up, down, left or right. A higher value causes movements to speed up as they continue in the same direction. |
| Diagonal Acceleration | Diagonal Acceleration sets the shape of a circular movement made with the mouse. Change the value and test the setting within the game by making a circular mouse movement. |

B. Curve Setting

The *Curve Setting* is for adjusting the relationship of **Mouse Velocity** (physical mouse speed) to **Aim Velocity** (on-screen speed). Click **Edit** to open.



Settings

Curve settings are used to fine tune how physical mouse movements respond on-screen (in the game). The default curve has a 1:1 ratio: Physical mouse speed equals on-screen speed. Adjustments can limit movements, stretch movements and increase or decrease progressive movements. The Curve Setting table is provided on the next page and information on making adjustments to the curve starts on page 45.

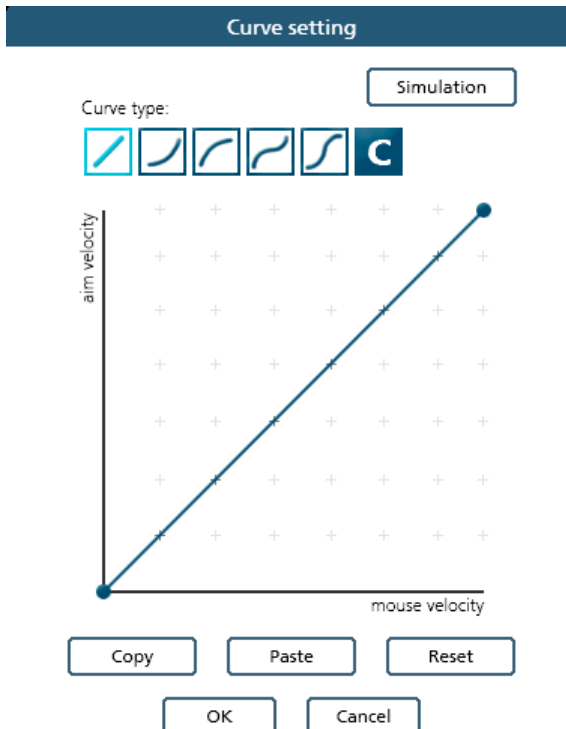

| Function | Description |
|---|--|
| Curve Type | Click a curve type to use a predefined curve for mouse movements. You can change the shape of a curve type at the points provided. Select a curve type to use as a template and then click Custom to adjust the curve to suit your needs. |
| Custom  | Use custom to make fine adjustments to the curve. When selected 24 points appear allowing you to adjust the shape of the curve. Click and drag the points up or down to make adjustments. You can select a Curve Type and then click Custom to adjust it as you wish. Examples are provided starting on page 47. |
| Aim Velocity | Aim Velocity refers to the speed of on-screen movements. |
| Mouse Velocity | Mouse Velocity refers to the speed of physical mouse movements. |
| Simulation | Use simulation when the Phantom-S is connected to a computer and game console to test the curve settings. Use [F12] to exit. |
| Copy | After customizing the curve you can copy your adjustments and paste them into another profile. |
| Paste | Paste a copied curve into the curve settings of another profile. |
| Reset | Resets the curve back the default values. |

Curve

The Curve is the relationship of **Mouse Velocity** (physical mouse speed) to **Aim Velocity** (on-screen speed). When the physical mouse and on-screen speed are the same, the curve looks like this:

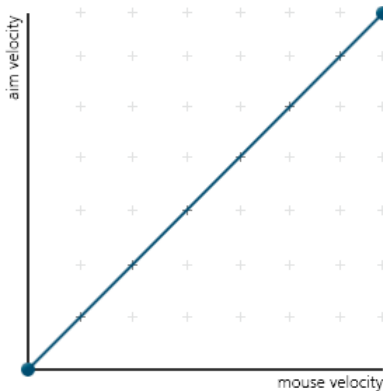

Mouse Velocity increases from left to right. **Aim Velocity** increases from bottom to top. As you adjust the curve up and down, the relationship of physical mouse speed to on-screen speed changes. The two sections represent different movements:

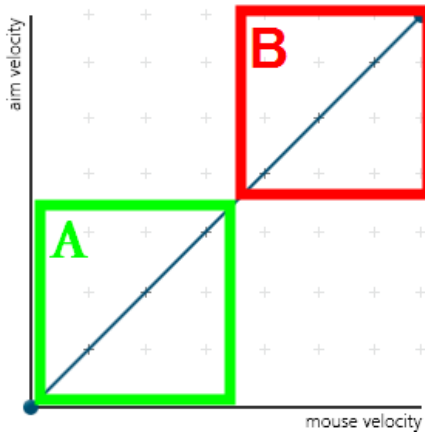

A: Close Aiming Movements **B:** Long Turning Movements

Pulling the Curve up makes the on-screen movements faster and pulling the Curve down restricts the speed – of **A** or **B** as the mouse is moved.

Adjusting the Curve

Adjusting the curve allows you to fine tune turn acceleration, deceleration, high and low speeds with limits, and boost velocity. Use the graph points to adjust the curve to suit your needs. Use the examples below to understand how adjusting (A) **Aiming** and (B) **Turning** affect movements in the game:

(A) Low Aim Speed / (B) High Turn Speed

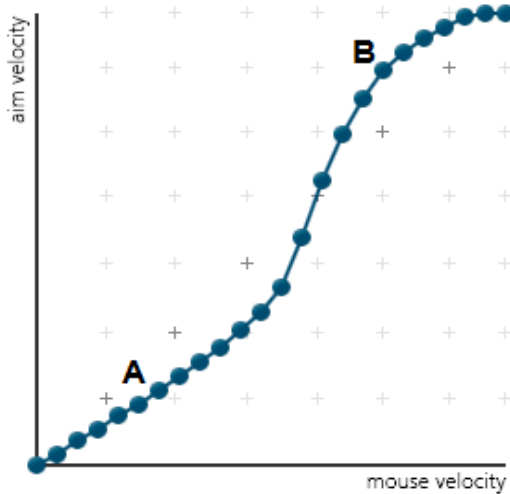

(A) Increasing Thrust for Aiming / (B) Prevent High Turn Speed

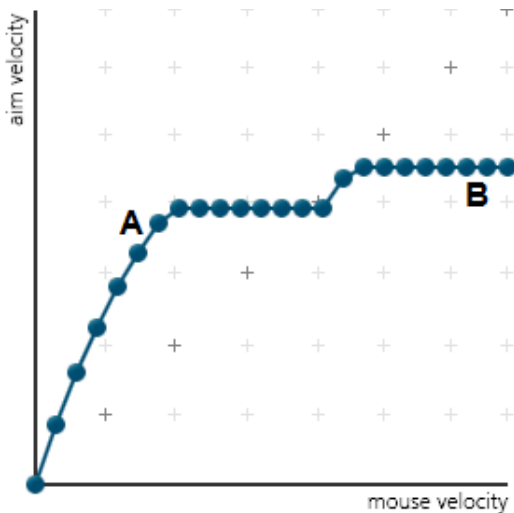

(A) Normal Aim Speed / (B) Increasing Thrust for Turning

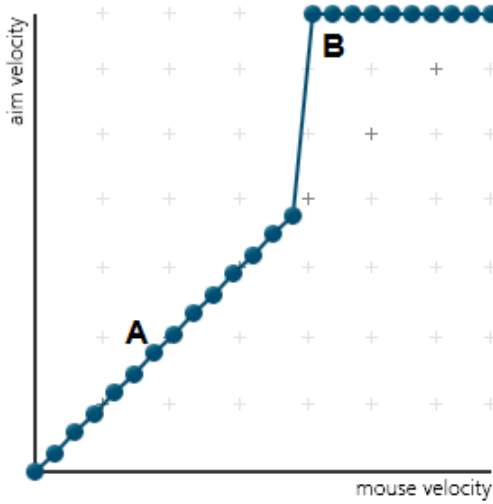

(A) Normal Aim Speed / (B) Low Turn Speed

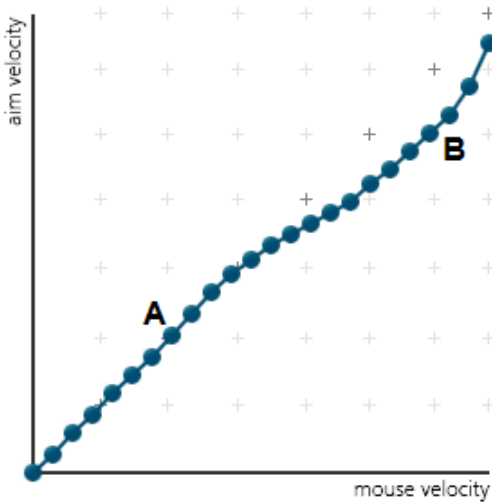

(A) Decrease Aim Speed / (B) Normal Turn Speed

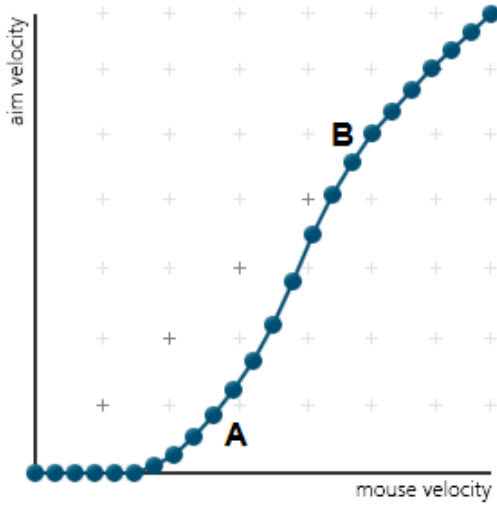

C. Deadzone Settings

The Deadzone Settings lets you adjust the size of the controller's Deadzone. Click **Edit** to open the Deadzone settings.

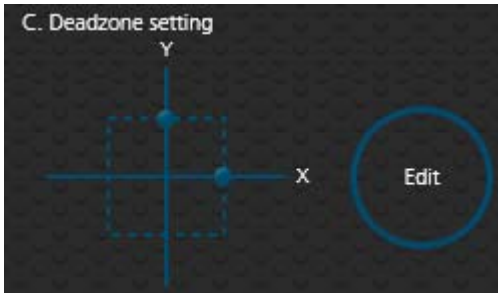

The Deadzone is a small area around the *Right Stick* control that doesn't respond to movement. Movement only occurs when the *Right Stick* moves outside the Deadzone. Each game sets its own Deadzone size. The Deadzone affects mouse movements. With no Deadzone there is no delay with the mouse and movements are very straight and accurate.

Right Stick Deadzone

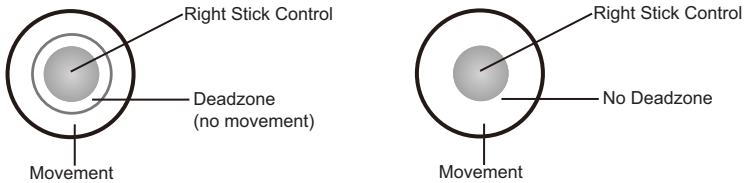

You can minimize the Deadzone with the game controller (see *Deadzone Delay*, page 21) or with the Phantom-S software as explained on the next page.

Setting the Deadzone

The Deadzone must be set while playing a first-person shooter (FPS) game. The Deadzone is minimized when— after the last adjustment on the graph, the player in the game starts to move slowly in the direction of the adjustment – up, right or diagonally up.

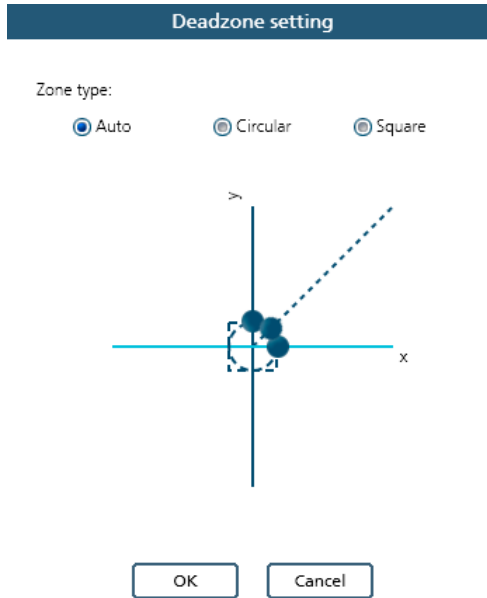

To set the Deadzone connect the Phantom-S to a computer & game console, then:

1. Start a first-person shooter (FPS) game and open the **Deadzone Settings**.
2. Select the **Zone Type**. If you do not know the zone type, select **Auto**.
3. Put the mouse cursor over one of the blue dots on the graph to display the arrows, as shown here:

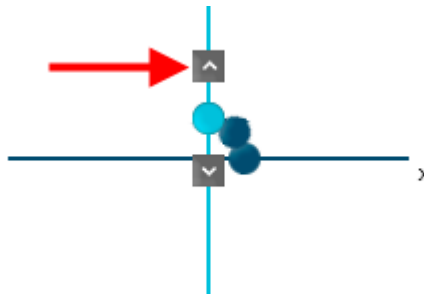

4. Click the arrow to increase the value (up or right) while watching the game until the player in the game starts to move slowly in the direction of the adjustment.

It's important that you stop adjusting the graph at the point (mouse click) where the player begins to move in the game – this is where the Deadzone is set perfectly. If you go past the point, simply click the arrow to decrease the value until the player stops moving and repeat step 4.

5. Repeat step 3 for each blue dot* on the graph.

Note: Its very important that you set each direction's Deadzone (X-axis, Y-axis and Diagonal) when using the **Auto Zone** Type.

6. Click **OK**, then click **Save** to save the Deadzone settings to the current profile, and then click **Upload** to upload the new Deadzone settings to the Phantom-S. You can also click **Save as** to save the profile to another Group.
7. Test the mouse within the first-person shooter game. Movements will be smooth, stable and accurate. You'll also notice that shooting becomes more steady and reliable than with the game controller.

If any mouse movements are shaky or jumpy repeat the steps to set the Deadzone. With the Deadzone set the mouse performance should be excellent. Also see *Quick Start Mouse Configuration*, page 12 for more mouse settings.

ADS Mode (Aim-Down-Sight)

Use these settings to set how the mouse movements respond when the character has zoomed in, such as through a scope. Except for the options listed below use the *Aim Look Mode* settings starting on page 43 to configure the ADS Mode settings.

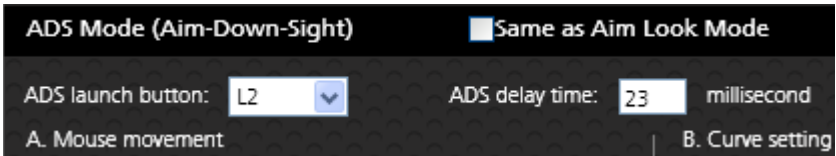

- ♦ **Same as Aim Look Mode:** Uncheck this box to configure the ADS Mode settings. Checking this box sets the ADS Mode to use the same settings as the Aim Look Mode.
- ♦ **ADS Launch button:** Use the drop-down menu to select the controller button that is used to zoom-in to an ADS view.
- ♦ **ADS delay time:** Sets the delay for switching between views: *Aim Look* and *ADS*.

Macro Settings

Macros set multiple controller buttons into a single key or mouse click. For example you can set: “**UP, UP, DOWN, LEFT, RIGHT, X, O**” to execute by pressing the [Y] key on the keyboard. Within macros you can set combos where multiple buttons are pushed at the same time: “**X+O**” or “**R3+L3+R2**”. You can create up to 8 custom macros and each macro can have up to 8 controller buttons.

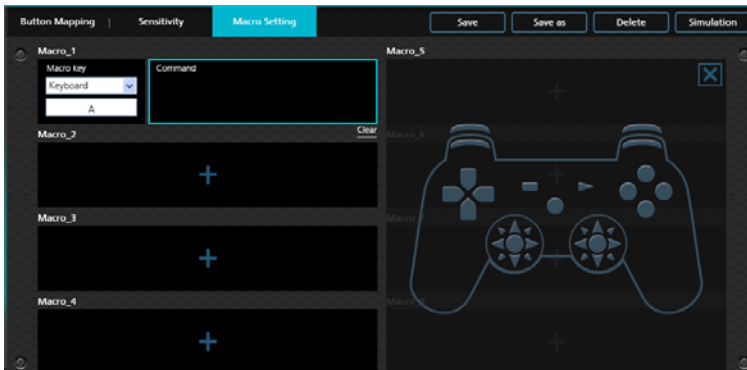

Macro Mode [F11] must be on for Macros to work (see *Macro Mode*, page 25).

| Function | Description |
|------------------|---|
| Macro Settings | Lists the macros created for the profile. Click + to add a macro. |
| Controller Image | The controller image appears when you click the command window. The image allows you to click a controller button to add it to the command box. |
| Command Window | <p>This is where your button commands appear when you click the controller image, enter up to 8 commands.</p> <ul style="list-style-type: none"> ◆ Combo (A+B+C): To create a combo button click between buttons in the command box. ◆ Clear: If you make a mistake and want to start over, use clear to delete all commands. <ul style="list-style-type: none"> ◆ + indicates the buttons are pressed together. ◆ > indicates buttons are pressed one by one. ◆ Click X to remove a button from the command. <p>Note: Combos are not considered a single command.</p> |

| Function | Description |
|------------------|--|
| Macro Key Window | The Macro Key is the <i>key</i> or <i>button</i> selected to execute the macro during gameplay. Select a device and choose a key or button: <ul style="list-style-type: none"> ◆ Keyboard: Press any key on the keyboard. ◆ Mouse: Select a button from the drop-down menu. ◆ Joystick: Select a button from the drop-down menu. ◆ None: Delete the macro command. |
| Save | After you enter the Macro Key and Command click Save to save the macro. |
| Simulation | Allows you to enter game mode to test the macro command. Use [F12] to exit. |

To create a macro:

1. Go to the **Macro Settings** page and click a macro box:

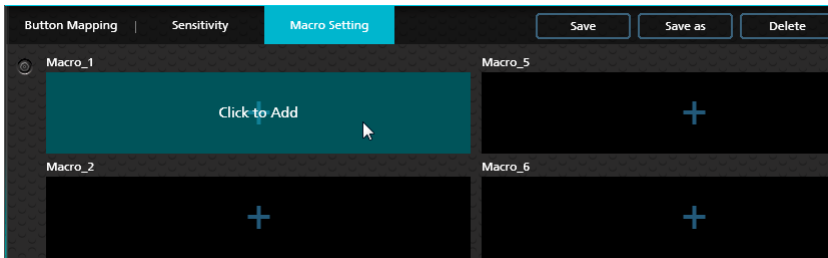

2. The **Macro Key** and **Command** page opens:

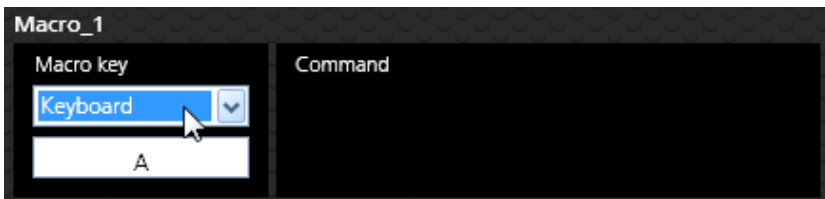

3. Use the **Macro Key** drop-down menu to select a device and button that will be used to execute the macro:
 - ◆ **Keyboard:** Click the box and press a key on the keyboard.
 - ◆ **Mouse:** Use the drop-down menu to select a mouse button.
 - ◆ **Joystick:** Use the drop-down menu to select a button.
 - ◆ **None:** Deletes macro.

- Click the **Command** window:

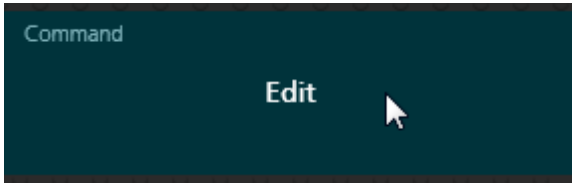

- A controller image appears to the right.

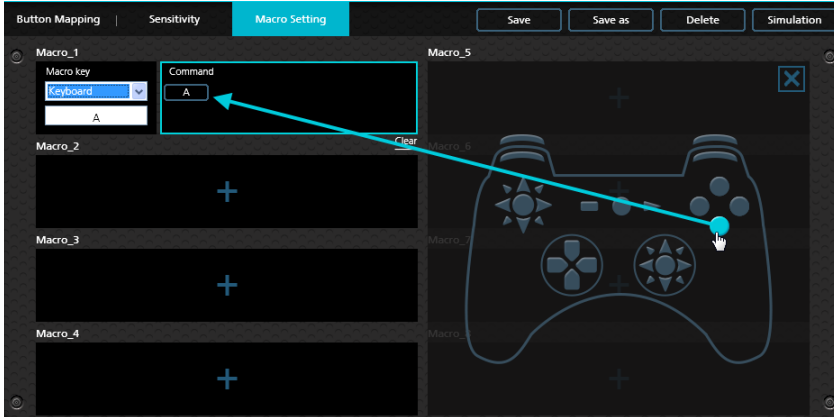

- Click a controller button to add it to the **Command** window in the order you want the buttons to execute:

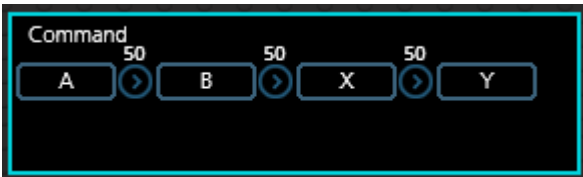

- Click on the values above the arrows to customize the command delay (default: 50 ms).

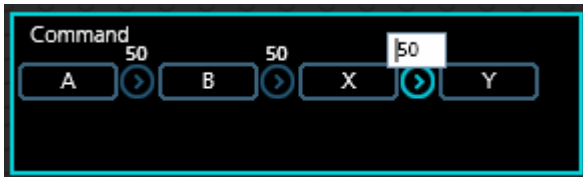

8. To remove the delay and create a combo button (A+B+C), click between the controller buttons. Click again to remove the combo.

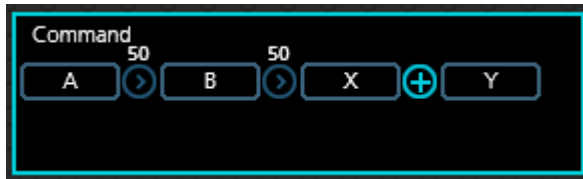

+ indicates the buttons are pressed together.

9. Move the mouse over a command and click **X** to remove the button or **Clear** to remove all buttons.



10. Click **Save**. The macro appears in the *Macro Settings* list:

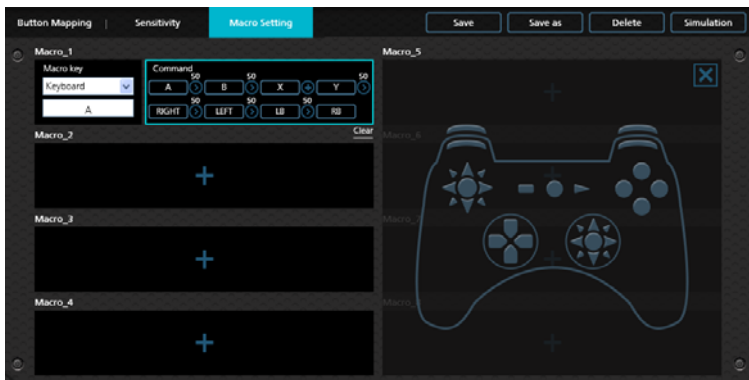

11. Enable *Macro Mode* by pressing [**F11**] from the keyboard connected to the Phantom-S (see *Macro Mode*, page 25).
12. Press the *Macro Key* set in step 3 to run the macro.

This Page Intentionally Left Blank

Chapter 5

Profile-X Web Portal

Overview

This chapter explains how to use the Profile-X Web Portal which allows you to share, request, discuss and save Phantom-S profiles and videos with other gamers.

Login

To access the Profile-X Portal, open the Phantom-S software and click **Go to Profile-X** (see page 28). The login page appears:

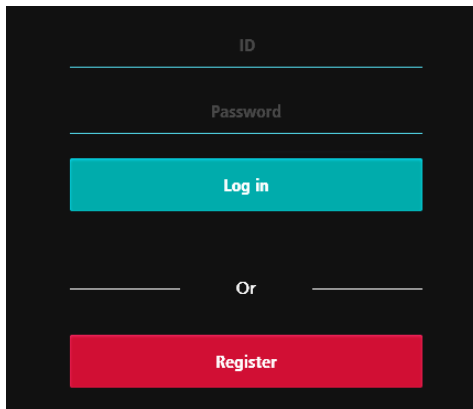

| Name | Details |
|----------|---|
| ID | Enter a username to login. The username is a combination of the First Name + Last Name (no spaces) that was provided to register your Phantom-S device. |
| Password | Enter the password that was provided when your product was registered. |
| Log in | After entering the ID, Password and Verification Code, click Log in to enter the portal. |
| Register | Click for product registration and to obtain a username and password to enter the site. |

The Main Page

After you have successfully logged in, the main page appears:

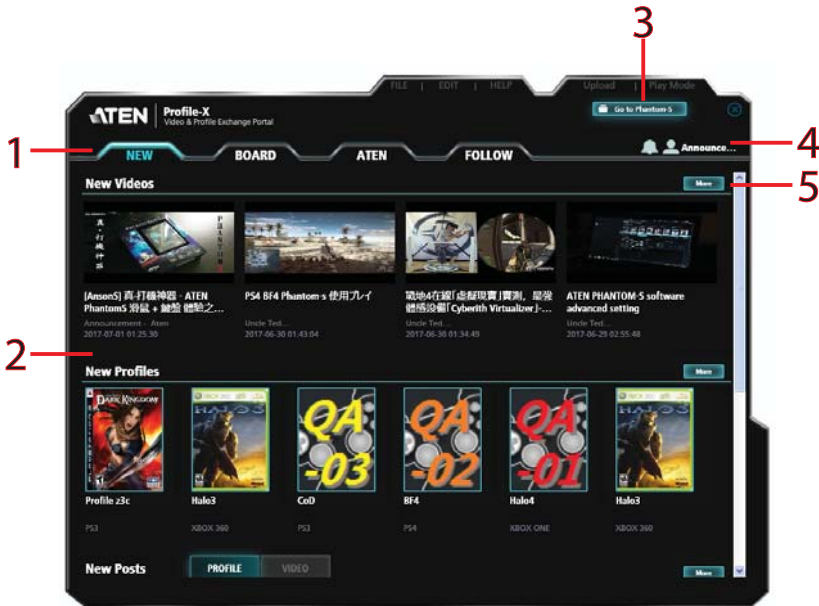







Components

The components are described in the table, below:

| No. | Item | Description |
|-----|---------------------------|--|
| 1 | Tab Bar | The tab bar contains the top navigation categories: New, Board, ATEN, and Follow. |
| 2 | Interactive Display Panel | This is the main interactive area. The screens that appear reflect your tab choice and page selection. |
| 3 | Go to Phantom-S | Click this button to return to the Phantom-S software. This will not log you out so that you can easily share and use profiles on your Phantom-S device. |
| 4 | Account Menu | This section contains the <i>Message Box</i> , <i>My Account</i> , and <i>Log off</i> options. |
| 5 | More | Clicking More opens a page that provides additional content within the relevant selection. Click < to return to the main page. |

The Tab Bar

The functions associated with each of the tabs and the account menu are explained in the table below:

| Icon | Function |
|---|--|
|  | New: The New tab displays recent videos, profiles and posts submitted to the Profile-X Portal. The New page is discussed on page 62. |
|  | Board: The Board tab provide a message board to view, share, and request Phantom-S profiles and videos. The Board page is discussed on page 63. |
|  | ATEN: The ATEN tab provides official ATEN news and updates. The ATEN page is discussed on page 66. |
|  | Follow: The Follow tab provides a way to track the users that you follow. The Follow page is discussed on page 67. |
|  | Message Box: The Message Box provides alerts about the posts of users your are following. The Message Box is discussed on page 67. |
|  | My Account: The My Account icon provides a link to manage your Profile-X user account. The My Account page is discussed on page 68. |

New

The *New* tab lists the most recent videos, profiles and posts submitted to the Profile-X Portal.

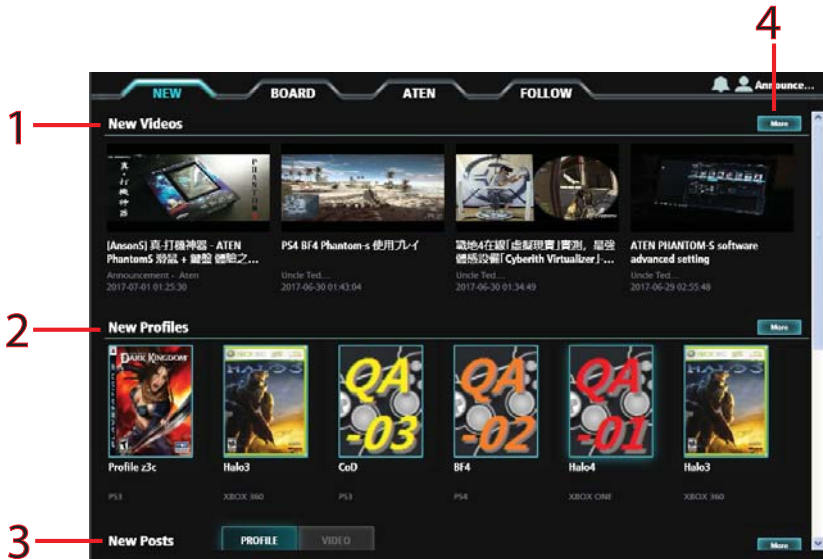

Components

The components are described in the table, below:

| No. | Item | Description |
|-----|--------------|--|
| 1 | New Videos | This section displays the most recent videos posted by users to the Board tab (see page 63). Click a post to view the video. |
| 2 | New Profiles | This section displays the most recent profiles posted by users to the Board tab (see page 63). Click a profile to download it to your device. |
| 3 | New Posts | This section lists the most recent profile and video posts submitted by users to the Board tab (see page 63). |
| 4 | More | Clicking More opens a page that provides additional content within the relevant selection. Click < to return to the main page. |

Board

The *Board* tab allows you to share and request Phantom-S profiles and videos.

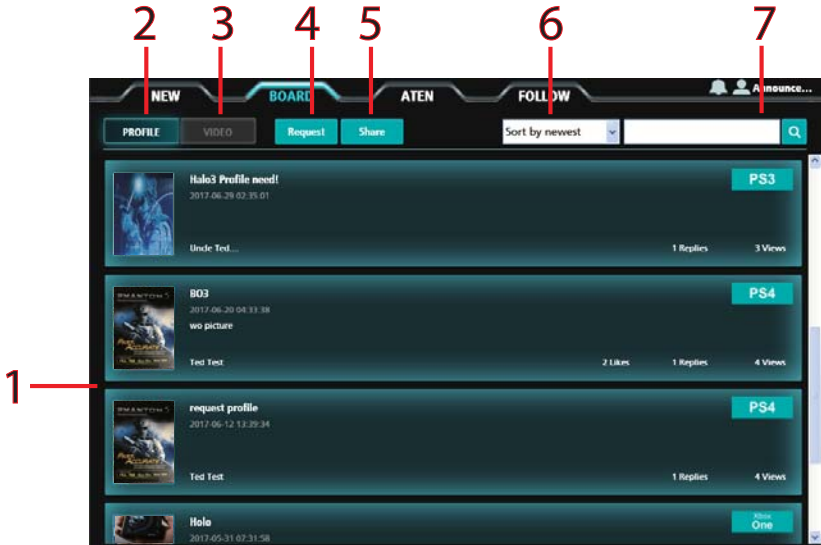

Components

The components are described in the table, below:

| No. | Item | Description |
|-----|---------------------------|--|
| 1 | Interactive Display Panel | This is the main interactive area where you can click to view, post and download content on the message boards. |
| 2 | Profile | Click to open the Profile board which allows you to download and request Phantom-S profiles. |
| 3 | Video | Click to open the Video board which allows you to view and share video links. |
| 4 | Request | Click to post a message requesting other users to share a game specific Phantom-S profile. |
| 5 | Share | Click to post a message that shares a profile uploaded from your Phantom-S device. |
| 6 | Sort | This drop-down menu sorts the order of posts on the message board. Options are: <i>Sort by newest</i> or <i>Sort by oldest</i> . |

| No. | Item | Description |
|-----|--------|--|
| 7 | Search | Key in a string and click Search to find a post or Phantom-S profile. To clear the search results, click the <i>Profile</i> icon or delete the string and click <i>Search</i> . |

Posting Messages

The Board tab allows you to share and request profiles and video links. Profiles can be downloaded and uploaded to the board from your Phantom-S device.

Request Profile

To request a profile, do the following:

1. From the Board tab, click **Request**. The *Request Profile* window appears:

2. Type in the *Game Name*, select the *Console*, and click **Submit**. The post will appear in the message board list.

Share Profile

To share a profile, do the following:

1. From the Board tab, click **Share**. The *Share Profile* window appears:

2. Fill in and select the appropriate information for your post:

- ♦ *Game Name* – enter the name of the game.
- ♦ *Description* – type information describing your post.
- ♦ *Select Profile* – choose a profile for the post.

Storage: Select where the profile is located.

Group: When uploading from the Phantom-S, select the Group.

Profile: Select the Phantom-S profile.

3. After selecting a profile, click **Submit**.

Share Video

To share a video, do the following:

1. From the Board tab, click **Video**.
2. Click **Share**. The *Share Video* window appears:

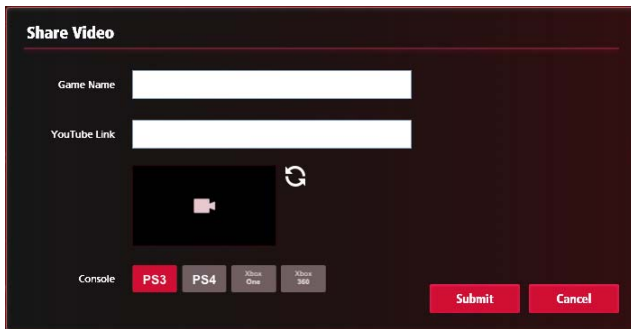

- ♦ *Game Name* – enter the name of the game.
- ♦ *YouTube Link* – enter the YouTube web address.
- ♦ *Console* – select a game console.

3. After entering the information, click **Submit**.

ATEN

The *ATEN* tab provides posts by ATEN with the latest Phantom-S news and updates.

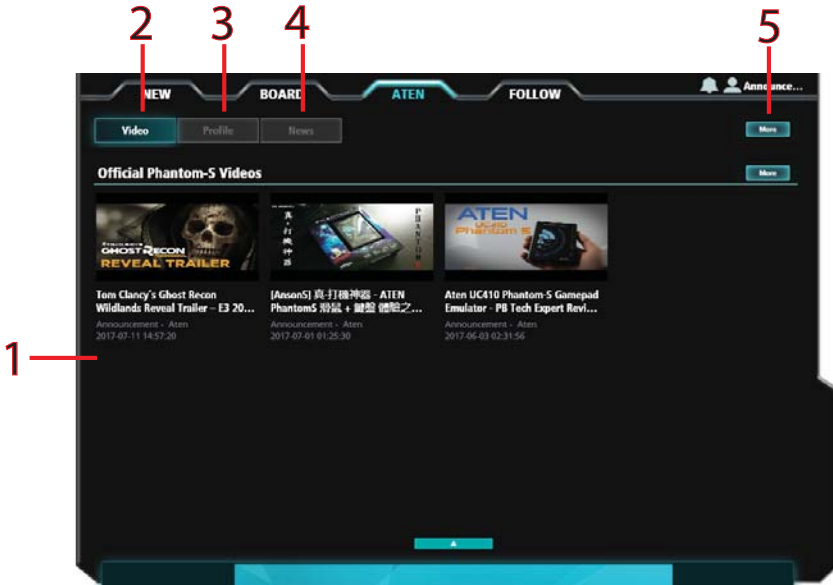

Components

The components are described in the table, below:

| No. | Item | Description |
|-----|---------------------------|--|
| 1 | Interactive Display Panel | This is the main interactive area where you can view and download content posted by ATEN. |
| 2 | Video | Click to open the Video board to view videos posted by ATEN. |
| 3 | Profile | Click to open the Profile board to view profiles posted by ATEN. To use a profile, select a post and click Download , then follow the instructions to save it to your Phantom-S device. |
| 4 | News | Click to open the News board to view the latest Phantom-S updates posted by ATEN. |
| 5 | More | Clicking More opens a page that provides additional content within the relevant selection. Click < to return to the main page. |

Follow

The *Follow* tab provides a list of the Profile-X users that you are following. Each time a user on this list posts a message an alert will appear in your message box.

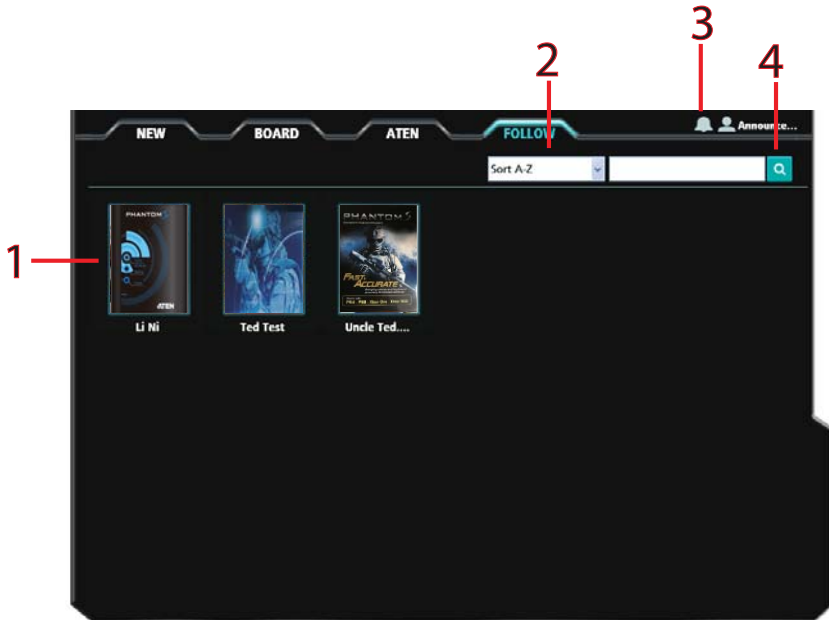

Components

The components are described in the table, below:

| No. | Item | Description |
|-----|---------------------------|---|
| 1 | Interactive Display Panel | This is the main interactive area where you can view the users you are following. Click an account to view profile information or to unfollow the user. |
| 2 | Sort | This drop-down menu sorts the order of posts on the message board. Options are: <i>Sort A-Z</i> and <i>Sort Z-A</i> . |
| 3 | Message Box | Click the bell to open the message box. Alerts appear in the message box when users that you follow post to a message board. |
| 4 | Search | Key in a string and click Search to find a user. To clear the search results, delete the string and click Search. |



My Account

Clicking *My Account* opens a page that displays information about your Profile-X account.

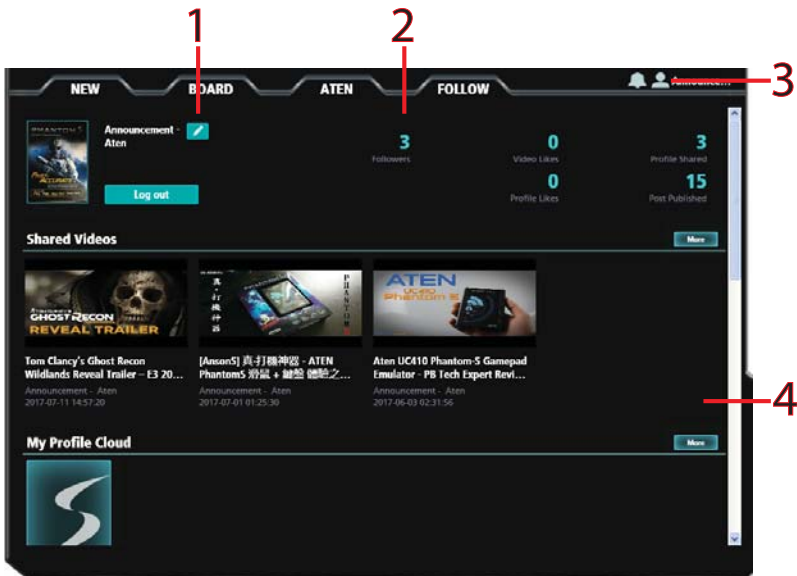

Components

The components are described in the table, below:

| No. | Item | Description |
|-----|-----------------|--|
| 1 | Edit | Clicking the Edit button allows you to change the name and photo that is displayed when posting messages. |
| 2 | User Statistics | This section displays the number of users you are following, video likes, profile likes, profile shares and published posts. |
| 3 | My Account | Clicking this icon allows you to log out or open My Account. |

| No. | Item | Description |
|-----|---------------------------|---|
| 4 | Interactive Display Panel | <p>This is the main interactive area where you can view a history of the content that you have posted and saved:</p> <ul style="list-style-type: none">◆ Shared Videos – lists all the video links you've posted.◆ My Profile Cloud – provides free online storage for your Phantom-S profiles. To upload profiles from your device, select <i>More</i> and then click Upload. Select any profile in your My Profile Cloud to download or delete it.◆ Downloaded Profiles – lists all the profiles that you've downloaded.◆ Published Posts – lists all the messages you've posted. |

Chapter 6

Firmware Upgrade

The Firmware Upgrade Utility

As new firmware versions become available firmware upgrade packages are posted on the ATEN web site. The Windows-based Firmware Upgrade Utility (FWUpgrade.exe) provides a smooth automated process for upgrading the Phantom-S's firmware. Check the web site regularly to find the latest firmware packages and information relating to them.

Before You Begin

To prepare for the firmware upgrade, do the following:

1. Go to www.aten.com/phantoms
2. Follow the instructions to download the firmware upgrade.
3. Unzip the firmware upgrade package and connect the computer to the Phantom-S.
4. Open the Phantom-S software, click *Help* and **Firmware upgrade**:

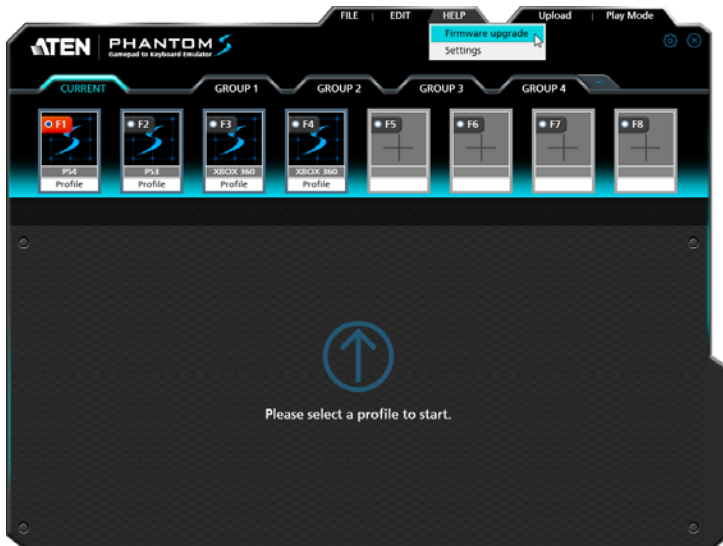

5. Browse to the firmware upgrade (*.exe) file, select it and click **Open**:

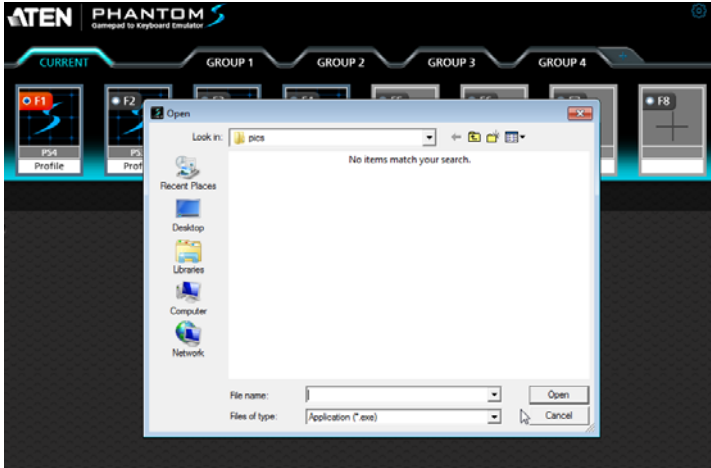

6. This will start the Firmware Upgrade Utility, as described in the next section.

Performing the Upgrade

Starting the Upgrade

1. The Firmware Utility inspects your installation. All the devices capable of being upgraded by the package are listed in the *Device List* panel.

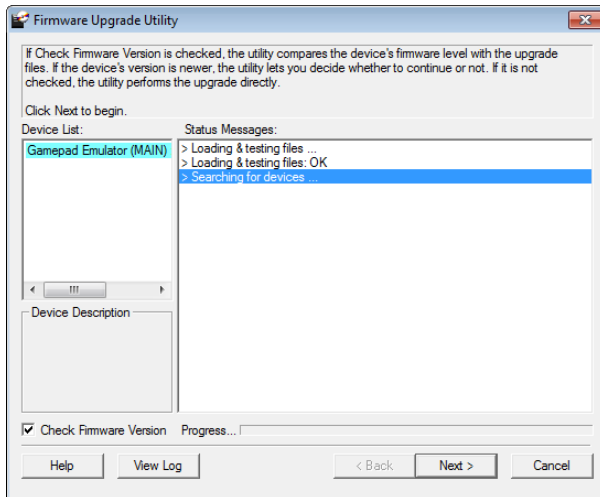

2. Click **Next** to perform the upgrade.

- ◆ If you enabled *Check Firmware Version*, the Utility compares the device's firmware level with that of the upgrade files. If it finds that the device's version is higher than the upgrade version, it brings up a dialog box informing you of the situation and gives you the option to continue the upgrade:

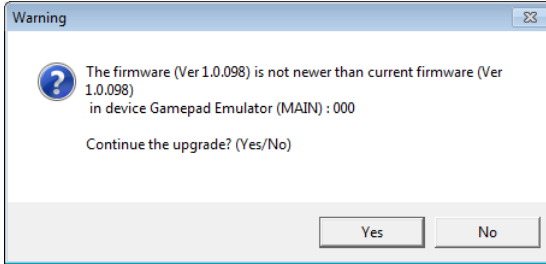

If you didn't enable *Check Firmware Version*, the Utility installs the upgrade files without checking whether they are a higher level, or not.

- ◆ As the Upgrade proceeds status messages appear in the Status Messages panel, and the progress toward completion is shown on the *Progress* bar.

Upgrade Succeeded

After the upgrade has completed, a screen appears to inform you that the procedure was successful:

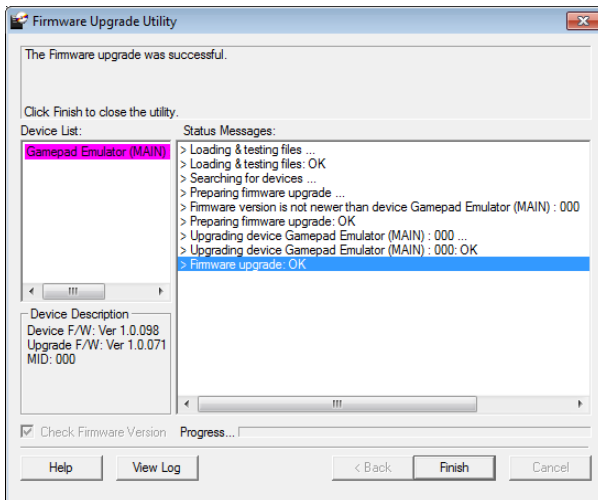

Click **Finish** to close the Firmware Upgrade Utility.

Upgrade Failed

If the upgrade failed to complete successfully the *Upgrade Failed* screen appears:

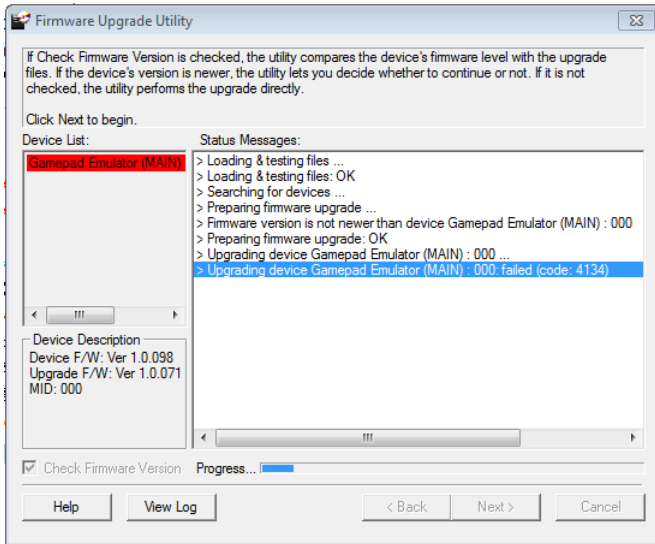

Click **Cancel** to close the Firmware Upgrade Utility. See the next section, *Firmware Upgrade Recovery*, for how to proceed.

Firmware Upgrade Recovery

There are three conditions that call for firmware upgrade recovery:

- ◆ When the unit's firmware becomes corrupted and you are unable to operate it.
- ◆ When a firmware upgrade procedure is interrupted or the Phantom-S is unplugged.
- ◆ When a firmware upgrade procedure fails.

To perform a firmware upgrade recovery, do the following:

1. Unplug the Phantom-S from the computer.
2. Use a pen or paper clip to press the **Reset** button on the Phantom-S.
3. With the **Reset** button pressed, connect the Phantom-S to the computer via the power and PC ports.
4. Hold the **Reset** button for 5 seconds.
5. Double click the *Firmware Upgrade Utility* to run it without the Phantom-S software.
6. Upgrade the firmware as explained in *Performing the Upgrade*, page 71.
7. Unplug the Phantom-S from the computer.
8. Plug the Phantom-S into the computer.

Safety Instructions

General

- ◆ This product is for indoor use only.
- ◆ Read all of these instructions. Save them for future reference.
- ◆ Follow all warnings and instructions marked on the device.
- ◆ Do not place the device on any unstable surface (cart, stand, table, etc.). If the device falls, serious damage will result.
- ◆ Do not use the device near water.
- ◆ Do not place the device near, or over, radiators or heat registers.
- ◆ The device cabinet is provided with slots and openings to allow for adequate ventilation. To ensure reliable operation, and to protect against overheating, these openings must never be blocked or covered.
- ◆ The device should never be placed on a soft surface (bed, sofa, rug, etc.) as this will block its ventilation openings. Likewise, the device should not be placed in a built in enclosure unless adequate ventilation has been provided.
- ◆ Never spill liquid of any kind on the device.
- ◆ Unplug the device from the wall outlet before cleaning. Do not use liquid or aerosol cleaners. Use a damp cloth for cleaning.
- ◆ The device should be operated from the type of power source indicated on the marking label. If you are not sure of the type of power available, consult your dealer or local power company.
- ◆ To prevent damage to your installation it is important that all devices are properly grounded.
- ◆ Do not allow anything to rest on the power cord or cables. Route the power cord and cables so that they cannot be stepped on or tripped over.
- ◆ To help protect your system from sudden, transient increases and decreases in electrical power, use a surge suppressor, line conditioner, or un-interruptible power supply (UPS).
- ◆ Position system cables and power cables carefully; Be sure that nothing rests on any cables.

- ◆ Never push objects of any kind into or through cabinet slots. They may touch dangerous voltage points or short out parts resulting in a risk of fire or electrical shock.
- ◆ Do not attempt to service the device yourself. Refer all servicing to qualified service personnel.
- ◆ If the following conditions occur, unplug the device from the wall outlet and bring it to qualified service personnel for repair.
 - ◆ The power cord or plug has become damaged or frayed.
 - ◆ Liquid has been spilled into the device.
 - ◆ The device has been exposed to rain or water.
 - ◆ The device has been dropped, or the cabinet has been damaged.
 - ◆ The device exhibits a distinct change in performance, indicating a need for service.
 - ◆ The device does not operate normally when the operating instructions are followed.
- ◆ Only adjust those controls that are covered in the operating instructions. Improper adjustment of other controls may result in damage that will require extensive work by a qualified technician to repair.

Technical Support

International

- ◆ For online technical support – including troubleshooting, documentation, and software updates: **<http://eservice.aten.com>**
- ◆ For telephone support, See *Telephone Support*, page iv:

North America

| | | |
|--------------------------|--|---|
| Email Support | | support@aten-usa.com |
| Online Technical Support | Troubleshooting Documentation Software Updates | http://www.aten-usa.com/support |
| Telephone Support | | 1-888-999-ATEN ext 4988 |

When you contact us, please have the following information ready beforehand:

- ◆ Product model number, serial number, and date of purchase.
- ◆ Your computer configuration, including operating system, revision level, expansion cards, and software.
- ◆ Any error messages displayed at the time the error occurred.
- ◆ The sequence of operations that led up to the error.
- ◆ Any other information you feel may be of help.

Specifications

| Function | | Phantom-S | |
|---------------------|------------------------|------------------------------|------------------------------------|
| Connectors | Front | Keyboard | 1 x USB Type A Female (White) |
| | | Mouse | 1 x USB Type A Female (White) |
| | | Gamepad | 1 x USB Type A Female (White) |
| | Rear | Game | 1 x Mini USB Type A Female (black) |
| | | PC | 1 x Mini USB Type A Female (black) |
| | | KB Power | 1 x Mini USB Type A Female (black) |
| Switches | Reset | 1 x Semi-recessed Pushbutton | |
| LEDs | Turbo / KB Mode | 1 (Orange) | |
| | Setting | 1 (Blue) | |
| | Power | 1 (Blue) | |
| Emulation | Keyboard | USB, Emulation | |
| | Mouse | USB, Emulation | |
| | Gamepad | USB, Bypass | |
| Power Consumption | | 5 V, 1.95 W | |
| Environment | Operating Temp. | 0–50°C | |
| | Storage Temp. | -20–60°C | |
| | Humidity | 0–80% RH, Non-condensing | |
| Physical Properties | Housing | Metal | |
| | Weight | 195 g | |
| | Dimensions (L x W x H) | 106 x 79 x 24.4 mm | |

Limited Hardware Warranty

ATEN warrants its hardware in the country of purchase against flaws in materials and workmanship for a Warranty Period of two [2] years (warranty period may vary in certain regions/countries) commencing on the date of original purchase. This warranty period includes the LCD panel of ATEN LCD KVM switches. Select products are warranted for an additional year (see A+ Warranty for further details). Cables and accessories are not covered by the Standard Warranty.

What is covered by the Limited Hardware Warranty

ATEN will provide a repair service, without charge, during the Warranty Period. If a product is defective, ATEN will, at its discretion, have the option to (1) repair said product with new or repaired components, or (2) replace the entire product with an identical product or with a similar product which fulfills the same function as the defective product. Replaced products assume the warranty of the original product for the remaining period or a period of 90 days, whichever is longer. When the products or components are replaced, the replacing articles shall become customer property and the replaced articles shall become the property of ATEN.

To learn more about our warranty policies, please visit our website:

<http://www.aten.com/global/en/legal/policies/warranty-policy/>