



Simply Better Connections

CS62US / CS64US

USB KVM Switch
User Manual

Compliance Statements

FEDERAL COMMUNICATIONS COMMISSION INTERFERENCE STATEMENT

This equipment has been tested and found to comply with the limits for a Class B digital service, pursuant to Part 15 of the FCC rules. These limits are designed to provide reasonable protection against harmful interference in a residential installation. Any changes or modifications made to this equipment may void the user's authority to operate this equipment. This equipment generates, uses, and can radiate radio frequency energy. If not installed and used in accordance with the instructions, may cause harmful interference to radio communications. However, there is no guarantee that interference will not occur in a particular installation. If this equipment does cause harmful interference to radio or television reception, which can be determined by turning the equipment off and on, the user is encouraged to try to correct the interference by one or more of the following measures:

- ◆ Reorient or relocate the receiving antenna.
- ◆ Increase the separation between the equipment and receiver.
- ◆ Connect the equipment into an outlet on a circuit different from that to which the receiver is connected.
- ◆ Consult the dealer or an experienced radio/TV technician for help.

The device complies with Part 15 of the FCC Rules. Operation is subject to the following two conditions: (1) this device may not cause harmful interference, and (2) this device must accept any interference received, including interference that may cause undesired operation.

FCC Caution: Any changes or modifications not expressly approved by the party responsible for compliance could void the user's authority to operate this equipment.



KCC Statement

유선 제품용 / B 급 기기 (가정용 방송 통신 기기)
이 기기는 가정용 (B 급) 전자파적합기기로서 주로 가정에서 사용하는
것을 목적으로 하며, 모든 지역에서 사용할 수 있습니다.

RoHS

This product is RoHS compliant.

CS62US / CS64US User Manual

Online Registration

Be sure to register your product at our online support center:

International	http://eservice.aten.com
---------------	---

Online Support

International

- ◆ For online technical support – including troubleshooting, documentation, and software updates: **<http://eservice.aten.com>**
- ◆ For telephone support, call this number:

International	886-2-8692-6959
China	86-400-810-0-810
Japan	81-3-5615-5811
Korea	82-2-467-6789
North America	1-888-999-ATEN ext 4988 1-949-428-1111

North America

Email Support		support@aten-usa.com
Online Technical Support	Troubleshooting Documentation Software Updates	http://www.aten-usa.com/ support
Telephone Support		1-888-999-ATEN ext 4988

Package Contents

Check to make sure that all the components are in working order. If you encounter any problem, please contact your dealer.

The CS62US / CS64US USB KVM Switch package contains the following items:

- ◆ 1 2-port CS62US USB KVM Switch
or 1 4-port CS64US USB KVM Switch
- ◆ 1 user instructions

Note:

- ◆ Read this manual thoroughly and follow the installation and operation procedures carefully to prevent any damage to the unit or any connected devices.
 - ◆ The product may be updated, with features and functions added, improved, or removed since the release of this manual. For an up-to-date user manual, visit <http://www.aten.com/global/en/>
-

Overview

The CS62US / CS64US takes a giant step forward from prior cable KVM models in the Petite series, by offering built-in cables, and USB peripheral sharing. A firmware upgrade function that is only supported by the CS64US allows you to keep up with latest available versions.

The CS62US / CS64US also offers multiplatform support and computer selection via hotkeys to provide the ultimate in desktop convenience.

Furthermore, the CS62US / CS64US features enhanced Video DynaSync™ technology, which stores the console monitor's EDID (Extended Display Identification Data) to optimize display resolution.

Featuring an unbeatable combination of design and functionality, USB peripheral sharing convenience, and enhanced user-friendly operations, the CS62US / CS64US allows users to keep up with the latest innovations in desktop multimedia applications.

Features

- ◆ One USB console controls two/four USB computers
- ◆ USB mouse port can be used for USB hub and USB peripheral sharing
- ◆ Computer selection via hotkeys
- ◆ Hotkey selection for OS and keyboard language
- ◆ Audio-enabled
- ◆ Multiplatform support – Windows, Linux, Mac, and Sun
- ◆ Compact design, built-in all-in-one cables
- ◆ Superior video quality – up to 2048 x 1536; DDC2B
- ◆ Video DynaSync™ – Exclusive ATEN technology eliminates boot-up display problems and optimizes resolution when switching between ports
- ◆ Independent switching of the KVM and audio focus
- ◆ Supports multimedia keyboards
- ◆ Supports wireless keyboards and mice
- ◆ Supports multifunction mice
- ◆ Mac/Sun keyboard support and emulation¹
- ◆ Auto Scan function to monitor computer operation
- ◆ HDCP Compliant
- ◆ Non-Powered
- ◆ Firmware upgradable²

Note: 1. PC keyboard combinations emulate Mac/Sun keyboards; Mac/Sun keyboards work only with their own computers.

2. Only CS64US supports firmware upgrade function.

System Requirements

Console

- ◆ A VGA, SVGA, or multisync monitor capable of the highest resolution that you will be using on any computer in the installation
- ◆ A USB keyboard and a USB mouse
- ◆ (Optional) Speakers

Computers

The following equipment must be installed on each computer that is to be connected to the system:

- ◆ A VGA, SVGA, or multisync video port
- ◆ USB Type-A port
- ◆ Speaker port (optional)

Cables

The CS62US / CS64US's innovative design features built-in KVM and speaker cables for extra convenience. No further cables are necessary.

Operating Systems

Supported operating systems are shown in the table, below:

OS		Version
Windows		2000 and higher
Linux	RedHat	9.0 and higher
	SuSE	10 and higher
	Mandriva (Mandrake)	2006, 2007, 2008
	Debian	3.1, 4.0
	Ubuntu	7.04, 7.10
UNIX	FreeBSD	5.5, 6.1, 6.2
	Sun	Solaris 9 and higher
Novell	Netware	5.0 and higher
Mac		OS 9 and higher
DOS		6.2 and higher

Components

CS62US

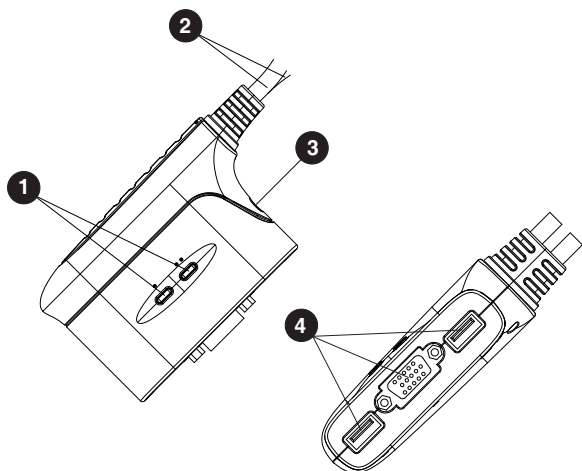

KVM Cable Connectors

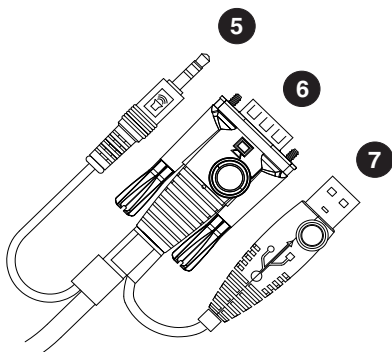

Note: The KVM cable connectors are the same on both models.

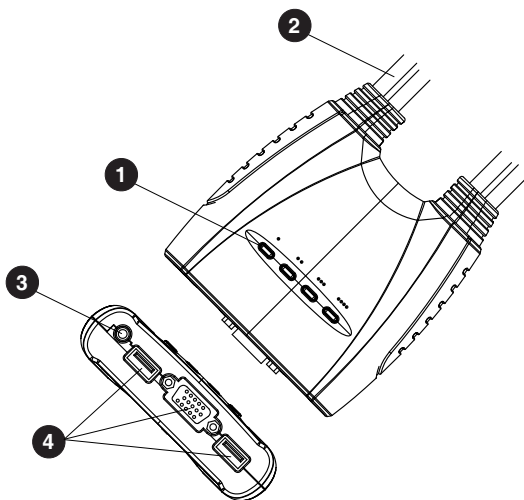

No.	Component	Description
1	port LEDs	The port LEDs light to indicate that the computer attached to its corresponding port has the KVM focus.
2	KVM cables	These cables attach to the computers in your installation.
3	speaker jack	Your console speakers plug in here.
4	console ports	The cables from your console monitor, USB keyboard, and USB mouse plug into these ports.
5	speaker connector	The connectors on the KVM cables plug into the computers in your installation. See <i>Installation Diagram</i> , page 14, for more information.
6	video connector	
7	USB keyboard / mouse connector	

Installation



1. Make sure that the power to any device that you connect to the installation has been turned off. You must unplug the power cords of any computers that have the *Keyboard Power On* function.
2. To prevent damage to your installation from power surges or static electricity. It is important that all connected devices are properly grounded.
3. Please operate the device with caution when under high environmental temperatures, as the surface of the device may become overheated under such conditions. For instance, the surface temperature of the device may reach 70 °C (158 °F) or higher when the environmental temperature reaches close 50 °C (122 °F).

Setting up the CS62US / CS64US USB KVM Switch is quick and easy. Refer to the installation diagrams on the following pages (the numbers in the diagrams correspond to the steps, below) and do the following:

1. Plug your USB keyboard, USB mouse, and monitor into their ports on the CS62US / CS64US. These are located on the side of the CS62US and the front of the CS64US.

Note: When using a wireless keyboard and mouse combo, the dongle must plug into the CS62US / CS64US's keyboard port in order for the hotkeys to function.

2. Plug your speakers into the speaker jack.
3. Plug the USB, video, and audio connectors of the attached KVM cables into their respective ports on the computers you are installing.
4. Power on the computers.

Note:

- ◆ The CS62US / CS64US's power on default is to link to the first computer that is powered on.
 - ◆ Make sure the computers and devices that the CS62US / CS64US connects to are also properly grounded.
-

Installation Diagram

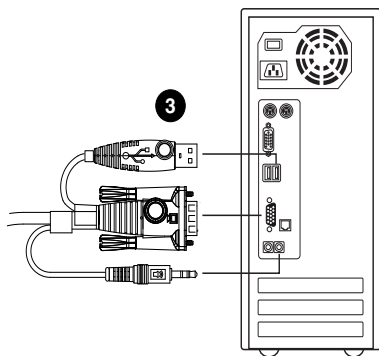
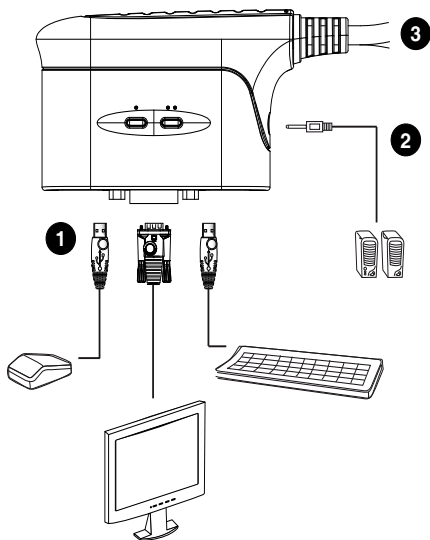

Port Switching

All port switching operations begin by tapping the Scroll Lock key twice. See the following table for full details.

Model	Hotkey		Action
CS62US	[Scroll Lock] [Scroll Lock]		Toggles the KVM and Audio focus between the two ports.
CS64US	[Scroll Lock] [Scroll Lock] +	[Enter]	Brings the KVM and Audio focus from the port that currently has the KVM focus to the next port on the installation (1 to 2; 2 to 3; 3 to 4; 4 to 1) Note: If the KVM and Audio focus are on different ports, only the KVM focus switches.
		[n] [Enter]	Brings the KVM and Audio focus to the computer attached to the corresponding Port ID. Note: Replace n with the port number (1, 2, 3, 4).

Example 1 (CS62US only)

To bring the KVM, USB hub, and audio focus from port 1 to port 2, do the following:

1. Press **[Scroll Lock]** twice.

Example 2 (CS64US only)

To bring the KVM, USB hub, and audio focus from port 1 to port 2, do the following:

1. Press **[Scroll Lock]** twice.
2. Press **[Enter]**.

Example 3 (CS64US only)

To bring the KVM and audio focus from a port to a specified port number (e.g., port 2), do the following:

1. Press **[Scroll Lock]** twice.
2. Press **[2]**.
3. Press **[Enter]**.

Mouse Port Selection

Simply double-click the scroll wheel on your USB mouse to switch between ports. The mouse port-switching function allows you to toggle back and forth between the ports.

-
- Note:**
1. This feature is only supported by CS62US.
 2. This feature is only supported by USB 3-key scroll wheel mice.
 3. The default setting is OFF.
 4. This feature is only supported when mouse emulation is enabled.
-

Model	Hotkey	Action
CS62US	[Num Lock] [-] [W]	Enables / disables mouse port-switching.

Invoking Hotkey Setting Mode (HSM)

All hotkey operations begin by holding the **Num Lock** key, pressing and releasing the **Minus** key, then releasing the **Num Lock** key. See the following tables for full details.

Note: If using [Num Lock] [-] conflicts with other programs, [Ctrl] [F12] can be used instead. See *Hotkey Summary Table*, page 18, for details.

Auto Scanning



















Model	Hotkey	Action
CS62US	[Num Lock] [-] [A]	Starts Auto Scan. The KVM focus cycles from port to port at 5-second intervals.
CS64US	[Scroll Lock] [Scroll Lock] [A] [Enter]	Starts Auto Scan. The KVM focus cycles from port to port at 5-second intervals.
	[Scroll Lock] [Scroll Lock] [A] [n] [Enter]	Starts Auto Scan. The KVM focus cycles from port to port at n-second intervals. Note: Replace n with a number between 1 and 99.

Note: To exit Auto Scan, press [Esc] or [Spacebar]. Auto Scanning stops when you exit Auto Scan mode.

Hotkey Summary Table

Combination		Function
[Num Lock] [-] +	[H]	Toggles between the default [Num Lock] [-] and alternate [Ctrl][F12] HSM invocation keys.
	[T]	Toggles between the default [Scroll Lock] [Scroll Lock] and alternate [Ctrl][Ctrl] port switching keys.
	[F2]	Activates Mac keyboard mapping.
	[F3]	Activates Sun keyboard mapping.
	[F10]	Activates Windows keyboard mapping.
	[F4]	Lists current switch settings via the paste function of a text editor.
	[F5]	Performs a USB keyboard and mouse reset.
	[F6] [nn] [Enter]	Sets the keyboard language layout. Note: nn is a two-digit number that represents one of the following keyboard language codes: US English 33; French 08; Japanese 15.
	[R] [Enter]	Resets hotkeys to the default setting.
	[M]	Enables / disables mouse emulation (CS62US only).
	[N]	Enables / disables keyboard emulation (CS62US only).
	[W]	Enables / disables mouse port-switching (CS62US only).
[u] [p] [g] [r] [a] [d] [e] [Enter]	Invokes Firmware Upgrade Mode (CS64US only).	
[Esc] or [Space Bar]		Quits hotkey setting mode.

Keyboard Emulation

Mac		Sun	
PC Keyboard	Mac Keyboard	PC Keyboard	Sun Keyboard
[Shift]	Shift	[Ctrl] [T]	Stop
[Ctrl]	Ctrl	[Ctrl] [F2]	Again
		[Ctrl] [F3]	Props
[Ctrl] [1]		[Ctrl] [F4]	Undo
[Ctrl] [2]		[Ctrl] [F5]	Front
[Ctrl] [3]		[Ctrl] [F6]	Copy
[Ctrl] [4]		[Ctrl] [F7]	Open
[Alt]	Alt	[Ctrl] [F8]	Paste
[Print Screen]	F13	[Ctrl] [F9]	Find
[Scroll Lock]	F14	[Ctrl] [F10]	Cut
	=	[Ctrl] [1]	 
[Enter]	Return	[Ctrl] [2]	 - 
[Backspace]	Delete	[Ctrl] [3]	 + 
[Insert]	Help	[Ctrl] [4]	
[Ctrl] 	F15	[Ctrl] [H]	Help
			Compose
			

Note: When using key combinations, press and release the first key [Ctrl], then press and release the activation key.

The Firmware Upgrade Utility

To upgrade the CS64US's firmware, do the following:

Note: Only CS64US supports The Firmware Upgrade Utility.

1. From a computer that is not part of your KVM installation, download the latest Firmware Upgrade package for the CS64US from our Internet support site (www.aten.com).
2. Invoke Firmware Upgrade Mode [**Num Lock**] [-] [**Upgrade**]. The LEDs flash together to indicate Firmware Upgrade Mode is in effect.

Note: While the switch is in Firmware Upgrade Mode, normal keyboard and mouse functions are suspended. You must complete the upgrade or exit Firmware Upgrade Mode to regain normal control of the console.

3. Run the Firmware Upgrade Package file. The *Firmware Upgrade Utility Welcome* screen appears.
4. Read the License Agreement and enable to *I Agree* button.
5. Click **Next** to continue. The Firmware Upgrade Utility main screen appears. All the devices capable of being upgraded by the package are listed in the *Devices List* panel.
6. Select your device. Its description appears in the Device Description panel. Click **Next** to perform the upgrade.
As the upgrade proceeds, status messages appear in the Status Messages panel, and the progress towards completion is shown in the *Progress* bar.
7. After the upgrade has completed, a screen appears to inform you that procedure was successful. Click **Finish** to close the Firmware Upgrade Utility.
8. Set up your KVM installation again. See *Installation*, page 12.

Upgrade Failed

If the Upgrade Succeeded screen doesn't appear, it means that the upgrade failed to complete successfully, in which case you should return the unit to your local service center for assistance.

Troubleshooting

Symptom	Possible Cause	Action
Mouse and/or Keyboard not responding.	Improper mouse and/or keyboard reset.	Unplug the cable(s) from the console port(s), then plug it/them back in.
	KVM switch needs to be reset.	Power off all devices on the installation (see safety note, page 9); power off the KVM switch; wait five seconds; then power up
USB devices not responding.	USB ports need to reset.	Unplug the device's USB cable from the USB port on the switch's rear panel, then plug it back in.
Device not recognized (Windows).	Windows timing problem.	Unplug the KVM cable from the computer's USB port; go into Windows' <i>System Settings</i> and remove the <i>Unknown Device</i> entry; plug the KVM cable back in. Windows will now recognize the device.
Cannot switch ports by pressing [Scroll Lock] twice	Keyboard is incompatible with Scroll Lock invocation.	Switch to the Alternate HSM invocation keys using hotkey [T] .
Cannot invoke HSM using [Num Lock][-]	Incorrect operation for invoking HSM.	Hold the [Num Lock] key, press and release the [Minus] key, then release the [Num Lock] key. The [Caps Lock] and [Scroll Lock] LEDs will flash together to indicate that the unit is in HSM.
	Keyboard is incompatible with [Num Lock] invocation.	Switch to the alternate HSM invocation keys by using hotkey [H] .

Factory Default Settings

Setting	Default
Port Switching	[Scroll Lock] [Scroll Lock]
Hotkey Invocation	[Number Lock] + [-]
Auto Scan Interval	5 seconds
Port Switching Keys	ON
Keyboard Operating Platform	PC compatible

LED Display Status

Status	Indication
Off	Port is not selected
On	Port is connected to an active computer
Flashing (one)	Port is connected to an active computer and is being accessed in Auto Scan Mode
Flashing (all)	Firmware Upgrade Mode is invoked

Specifications

Function		CS62US	CS64US		
Computer Connections		2	4		
Console Connections		1	1		
Port Selection		Hotkeys			
Connectors	Console Ports	Keyboard	1 x USB Type A-Female (White)		
		Video	1 x HDB-15 Female (Blue)		
		Mouse	1 x USB Type A-Female (White)		
		Speakers	1 x Mini Stereo Jack Female (Green)		
	KVM Ports	Keyboard / Mouse	2 x USB Type-A Male (White)	4 x USB Type-A Male (White)	
		Video	2 x HDB-15 Male (Blue)	4 x HDB-15 Male (Blue)	
		Speakers	2 x Mini Stereo Jack Female (Green)	4 x Mini Stereo Jack Female (Green)	
LEDs	Selected	2 (Green)	4 (Green)		
Cable Length		2 x 0.9 m	2 x 0.9 m; 2 x 1.2 m		
Emulation	Keyboard / Mouse	USB			
Video		2048 x 1536; DDC2B			
Scan Interval		5 sec.	1–99 sec. (default 5 sec.)		
Power Consumption		DC5V:0.33W:14BTU	DC5V:0.9W:8BTU		
Environment	Operating Temp.	0–50°C			
	Storage Temp.	-20–60°C			
	Humidity	0–80% RH, Non-condensing			
Physical Properties	Housing	Plastic			
	Weight	0.28 kg (0.62 lb)	0.58 kg (1.28 lb)		
	Dimensions (L x W x H)	8.75 x 6.08 x 2.80 cm (3.44 x 2.39 x 1.10 in)	9.41 x 9.72 x 2.6 cm (3.7 x 3.83 x 1.02 in)		

Limited Hardware Warranty

ATEN warrants its hardware in the country of purchase against flaws in materials and workmanship for a Warranty Period of two [2] years (warranty period may vary in certain regions/countries) commencing on the date of original purchase. This warranty period includes the [LCD panel of ATEN LCD KVM switches](#). Select products are warranted for an additional year (see [A+ Warranty](#) for further details). Cables and accessories are not covered by the Standard Warranty.

What is covered by the Limited Hardware Warranty

ATEN will provide a repair service, without charge, during the Warranty Period. If a product is defective, ATEN will, at its discretion, have the option to (1) repair said product with new or repaired components, or (2) replace the entire product with an identical product or with a similar product which fulfills the same function as the defective product. Replaced products assume the warranty of the original product for the remaining period or a period of 90 days, whichever is longer. When the products or components are replaced, the replacing articles shall become customer property and the replaced articles shall become the property of ATEN.

To learn more about our warranty policies, please visit our website:

<http://www.aten.com/global/en/legal/policies/warranty-policy/>

© Copyright 2022 ATEN® International Co., Ltd.
Released: 2022-08-19

ATEN and the ATEN logo are registered trademarks of ATEN International Co., Ltd. All rights reserved. All other brand names and trademarks are the registered property of their respective owners.