

75

105

**TOOLTEST**  
wire map cable tester  
**user manual**



**Hobbes**  
INNOVATION

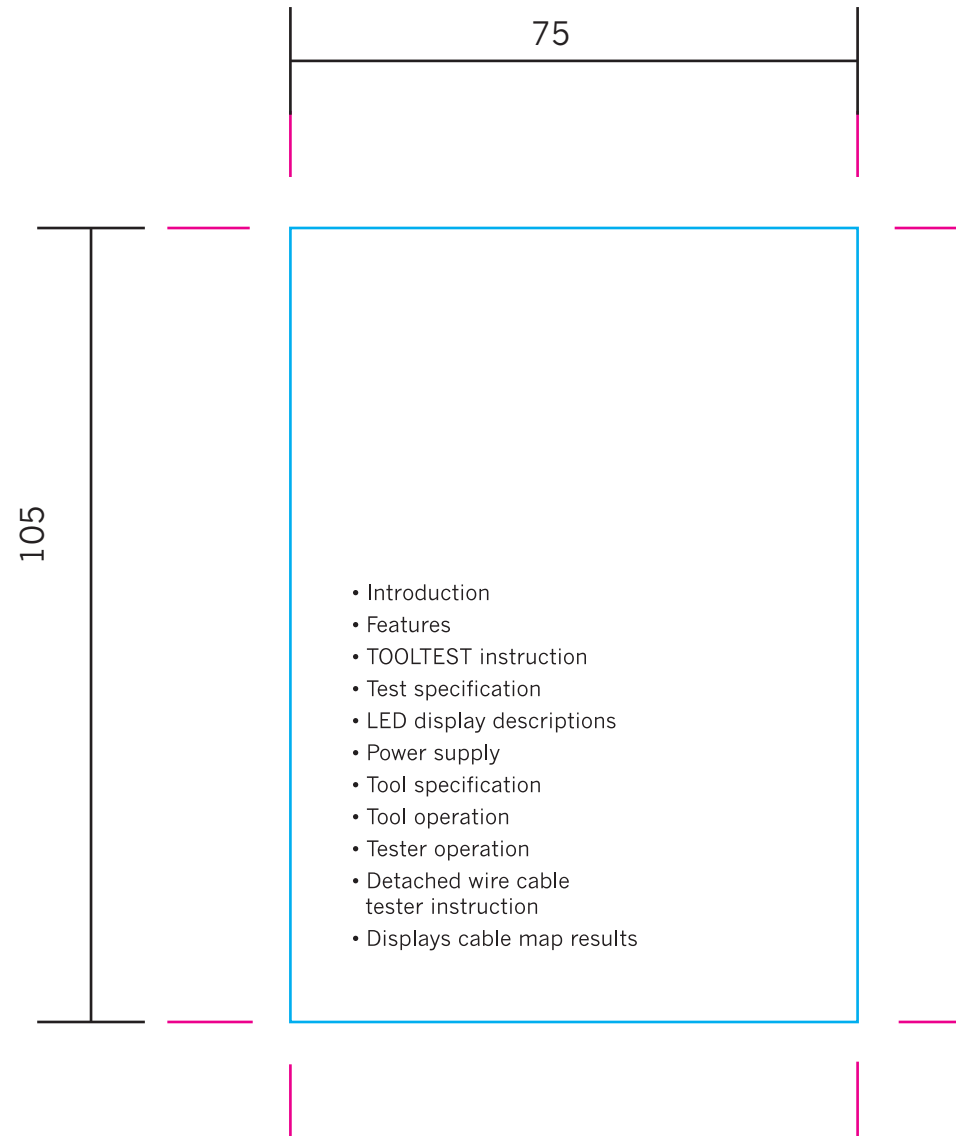

75

105

TOOLTEST is a small hand held cable map tester. It enables network professionals to quickly and easily test Ethernet twisted pair cable for wiring continuity, opens, shorts, and mis-wires. With a single push of the TEST button, TOOLTEST will automatically test cable and indicate the result of the cables pin-to-pin configuration.

With its unique combination of a Crimping Tool and a Cable Tester in one, it is the smallest and most convenient and innovative tool in the market worldwide today.

03

75

105

**Features**

- Testing for both UTP and STP cable
- Testing cable for continuity, opens, shorts, mis-wires
- Pin-to-pin indication
- Dual-Mode Test Function: Single and Continuous Test
- Auto Power Saving
- Low Power Indicator
- Single and Multi-Wired Cable Crimping
- Modular Crimping Plugs: 8P8C (RJ-45), 6P6C (RJ-12), 6P4C (RJ-11)
- Integrated cable stripper and cutter
- Crimping Tool and Cable Tester in One
- Detachable Cable Tester

04

75

105

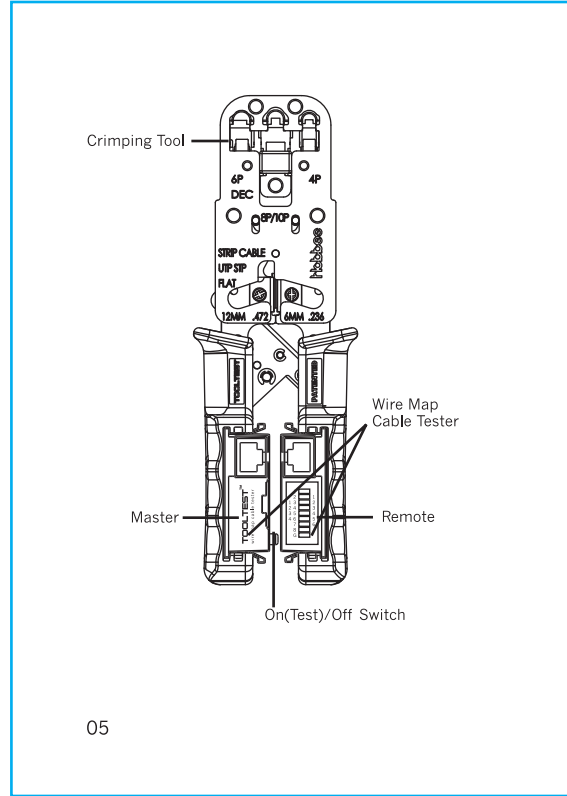

05

75

105

**Tester specification**

**Main unit**

- **Test Method**  
Pin-to-Pin LED indicators
- **Detect wiring faults**  
Open, short, mis-wire
- **Shielding verifying**  
Verification of shield/ground integrity
- **Power saving**  
Auto Off function
- **Battery low**  
LED flash indicator

**Remote unit**

- **Display method**  
LED

**LED Display Descriptions**

LED #1 to #8: 8 Pin wire configuration  
LED #1: Low Battery Indicator; LED flashes repeatedly to indicate the unit is low in battery before each testing.  
LED G: Shield/Ground  
RJ-11 (Color-Green): PIN1-PIN4, RJ-12 (Color-Yellow): PIN1-PIN6, RJ-45 (Color-White)

06

75

105

**Power supply**

- Main unit: DC4.5V (3 x LR-44 type batteries)
- While putting the battery, please pay attention to the polarity of the battery, in order to prevent the overheated phenomenon of battery.

**Tool specification**

Ratchet style crimper

For Crimping Modular Plugs

8P8C/RJ-45, 6P6C/RJ-12, 6P4C/RJ-11,  
4P4C 4P2C Plug & DEC/OFF SET Plug 6P6C

07

75

105

**Tool operation**

Ratchet type: Squeeze the handles until it stops to open the handles

1. Insert cable between stripper blades
  - a. Insert 4p or 6p cable from the top end of the stripper block until it touches the stop guide (stripping length 6mm).

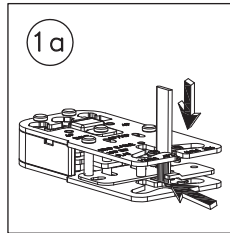

08



75

105

b. Insert 8p cable between stripper blades and let it extend a little past the lower cutter blade. (stripping length 12mm).

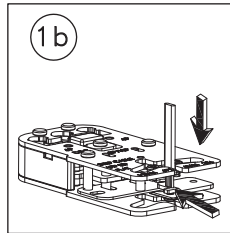

09

75

105

c. Insert UTP/STP cable from the lower end, let it extend a little past. Close to the handle and turn counterclockwise to a full circle

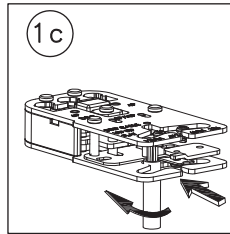

10

75

105

2. Cables must be kept perpendicular when squeezing handles and pull it from tool.

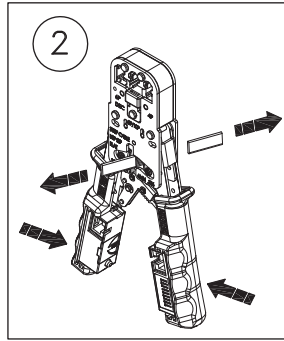

11

75

105

3. Insert the stripped cable into the plug (wires must be the same length after stripping and make sure wires are well set under golden contacts).

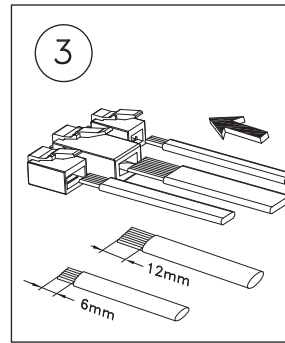

12

75

105

4. Place modular plug with wires into the tool holder (wires should be between the tab and gold contacts), then Squeeze handles until it stops.

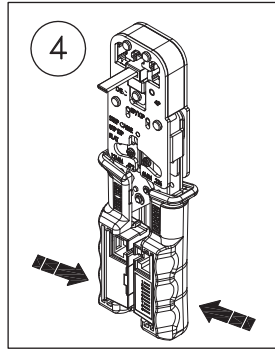

13

75

105

5. Remove the crimped plug from the tool

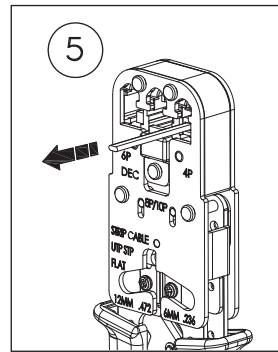

75

105

6. Remind: during the crimping process, you may turn the screw on the ratchet. Counter clockwise to stop the incorrect operation. (Ratchet Release)

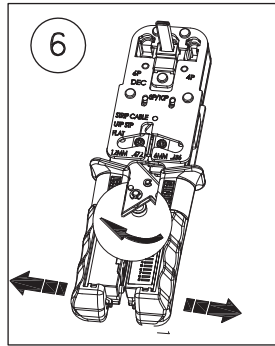

15

75

105

7. To crimp "DEC" plug, follow steps 1 to 3. Then insert the "DEC" plug & wires into the 6P holder, and squeeze handle until it stops.

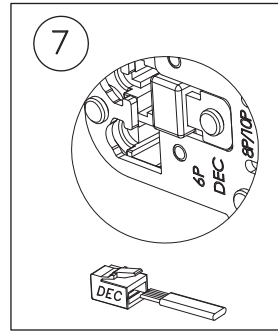

16



75

105

**Tester operation**

Cable Testing

1. Plug one end of the cable to be tested on the main unit and the other end to the remote unit
2. While testing the 6P6C, 6P4C cable, please plug it into the jack of tester harder due to it is mini-sized design
3. Dual-Mode testing function:
  - Single Test: Press "Test" key to start the test. (Pressing the "Test" key for less than one second, will run a single test).
  - Multiple Tests: Press and hold the "Test" key for 3 seconds, the tester will run a multiple test repeatedly (12 Times)

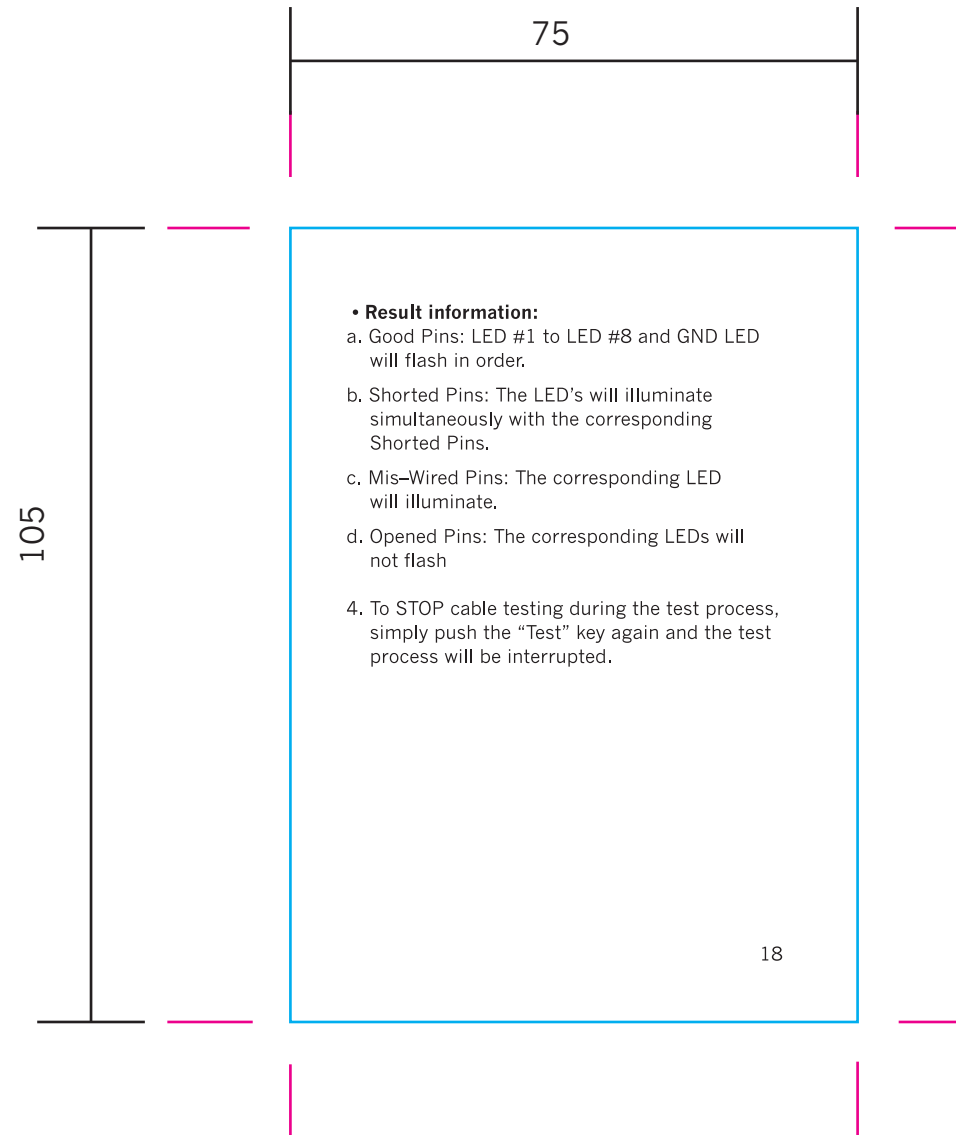

75

105

**Note: It's normal condition when testing cables with 4 pins and 6 pins, the test result will appear after few seconds.**

5. Auto Power: During Single Test, unit will power off automatically when testing process had concluded.
6. Battery Low Indicator: The first lightening LED will flash 4 times when TEST button is pressed.  
Remark: Please noted the LED might not lights up in order, it depends on the wire map condition of the cables. Detached Wire Cable Tester Instruction

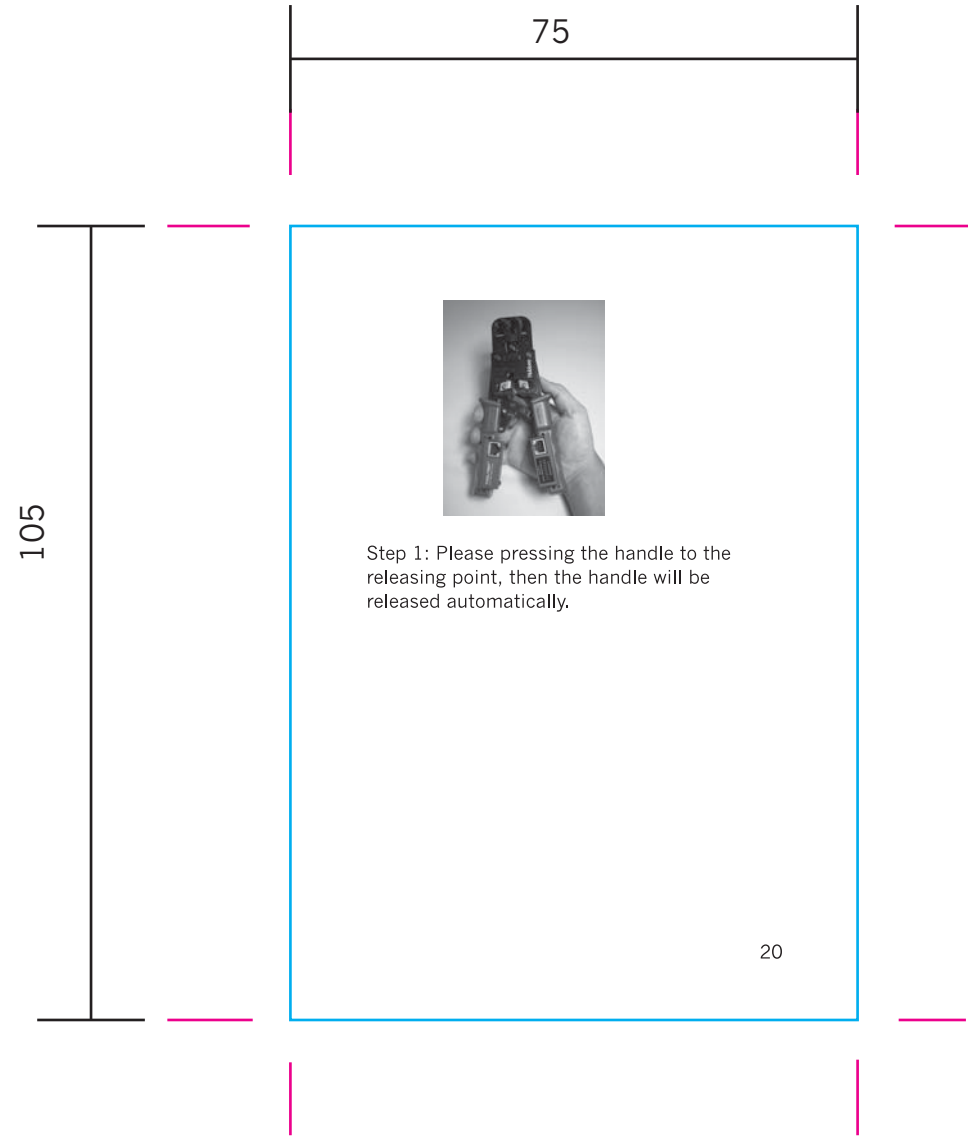

75

105

Step 2: Please detach the wire map cable tester by pressing the two pins on top and bottom of housing.



Step 3: Detach completed



21

75

105

Tooltest displays cable map results for pass, short, mis-wire by pin-to-pin, the following explains the results in details:

12345678G => LED PIN 1 to PIN G  
12345678G => Actual test result  
G: Ground

**RJ-45 Cable:**

Pass: The LED will light up from PIN 1 to PIN G by orderly after wire map tested if the corresponding pins are pass

Standard line: 12345678G  
Actual test result: 12345678G

1	█
2	□
3	□
4	□
5	□
6	□
7	□
8	□
G	□

22

75

105

Short:  
The LED will light up of PIN1, PIN2, PIN7 and  
PIN8 after the wire map tested if these  
corresponding pins are shorted.

Standard line: 12345678G  
Actual test result: 12345678G

- 1
- 2
- 3
- 4
- 5
- 6
- 7
- 8
- G

23

75

105

Mis-wire:

The LED will light up disorderly after wire map tested if these corresponding pins are miswired.

Standard line: 12345678G  
Actual test result: 68745321



24



75

105

Battery low: The first lightening LED will flash 4 times when battery is low.

Remark: Please noted the LED might not lights up in order, it depends on the wire map condition of the cables.

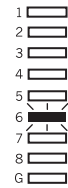

25

